

Vex™ Machinations: A Step-by-Step Project Guide

Version 2.0

Project Design and Programming: Justin Petersen
(except where otherwise noted)
Compilation: Yolande Petersen

© Justin Petersen and Yolande Petersen
2008, 2009

Table of Contents

Preface

Before You Begin

2009 Update

Part 1: Beginning Mechanical Projects

1. Basicbot
2. Flexigearbot
3. Ping Pong Shooter
4. Animal Grabber – Part 1: The Gripper
5. Animal Grabber – Part 2: The Lift

Part 2: Beginning Programming Projects

1. The Kentucky Do-Nothing
2. Scaredybot
3. Edge Detector
4. Line Follower
5. Boomerang
6. Light Seeker

Part 3: Advanced Mechanical Projects

1. Tricycle Drive
2. Cup Crusher
3. Holonomic Drive
4. Chin-upbot
5. Candy Sorter

Where to from here?

Appendix A: Recommendations for Vex kit purchase (Summer 2009)

Preface

The Vex™ Robotics Design System was made for creating designs from scratch, and experienced robot builders will find themselves in inventors' heaven. However, builders without much experience may struggle to put together even a simple robot that actually works. Step-by-step instructions are given for the Squarebot in the Vex™ Inventor's Guide, but trying to build unique designs beyond that can be an insurmountable challenge to builders without a foundation in basic mechanics. So far, few projects with step-by-step instructions are available (two new official projects are projected to be released by Fall 2008 on the Vex Robotics website). Many ingenious Vex™ robot designs are posted on the internet but few of them explicitly tell you which parts they use. An eager builder may attempt some of these designs, only to run out of parts mid-way through the project. After a few false starts, discouragement sets in.

Having a few projects with instructions can increase a builder's confidence and experience until s/he gets a "feel" for how the parts go together. Each project in this guide demonstrates a different mechanical or programming principle, and together with *Vex™ for the Technically Challenged*, can provide a basic foundation of some important engineering principles.

Part I (Starter Kit Projects) is designed for those who have purchased only the Starter Kit and would like to build a few fun things without investing more money (yet). Part II (Beginning Programming Projects) is designed to introduce a variety of sensors and includes projects that are mechanically simple enough to be built with the Starter Kit. The programs are also deliberately simple enough to introduce non-programmers to just a few concepts at a time. Part III (Advanced Mechanical Projects) delves into some deeper mechanical concepts and uses a variety of parts.

A note to educators: Students usually prefer to dive in and build a gadget that does something funky, rather than being blasted with theory. However, these projects were selected and arranged around something vaguely resembling a curriculum, with an aim to introduce important engineering concepts in an underhanded way. If all the projects in this manual are completed, the students will have used many of the sensors and important mechanical parts that were available as of this writing. More importantly, they will hopefully emerge with a reasonable grasp of important mechanical and programming principles that will move them in the direction of being able to design and construct their own projects.

We would like to thank our teammates from Team Metal Gear (Alexa Adams, Nathan Anthony, Eric Flores, Rafi Mitri, Alan Chambers, and Ryan Chambers), for their participation in the earlier version of this project, and also for making our robotics experience a fun and wild ride. Most of all, we would like to thank the Great Inventor for carrying us on this incredible journey.

Justin Petersen, Mechanical Guy
Yolande Petersen, Team Mom & Coach
June 16, 2008

Before You Begin

Nearly all of the projects in this guide require cutting of the metal pieces that come in the kit. In many cases, the cut pieces are more useful than the full-length pieces: having a 5-inch angle bar and a 10-inch angle bar is usually more beneficial than having a 15-inch angle bar, and having two 6-inch square bars is generally preferable to having a single 12-inch square bar. However, one important thing to consider is that while a large piece can be made into several small pieces, it is usually not possible to fuse several small pieces to create a larger one. Also consider that there are a number of possible cutting configurations for each piece—what if the 12-inch square bar was not needed in the form of two 6-inch square bars, but three 4-inch square bars instead?

If you plan to build a large collection of Vex parts, you should be able to cut what you need without leaving yourself in a hole. However, if your resources are limited and you feel squeamish about cutting your brand new Vex parts, fret not. In many cases, the projects in this guide can be built using larger versions of other parts. For example, a 15-inch angle bar may be substituted for a 10-inch angle bar, simply leaving 5-inches of extraneous material hanging off. This is not feasible in all situations—sometimes the extra hanging off could interfere with a moving part of the robot, and replacing a 5-inch angle bar with a 15-inch leaves such a large portion of metal hanging out that its weight may hinder the robot's balance. However, if you find yourself with a long bar strip or plate that is a few holes too large, or a square bar that is a little bit too long, you can usually get away with using it and not trimming off the excess length. See this excerpt from the Animal Grabber building instructions for an example of when it's okay to have a piece of metal that is slightly too long:



Although the strip in the middle is the ideal length (six holes), the seven-hole strips still adequately perform the function of holding the two bearing flats.

The microcontroller has 3 "strips" of ports: motor (with 8 slots), analog/digital (16 numbered slots, plus RX & TX slots), and interrupt (6 slots). The analog/digital strip is used for analog inputs, digital inputs, and digital outputs. We reference these ports throughout the guide. For example "digital input 6" means slot #6 on the analog/digital strip.

In Part II of the guide, many projects call for the use of a Basicbot or Flexigearbot. However, in most cases these specific models are recommend simply on the basis of ease of mounting. If you have a similar robot on which you can mount the "peripherals" added for sensor use, you are free to use that robot as a substitute.

Many of the programs included in the project are functional but inelegant. Because an effort was made to present them in the simplest way possible, many of them

include areas where performance can be dramatically enhanced with a little tweaking. Probably the easiest programming segments to modify are motor speed and timing (especially while turning), but clever programmers may find different ways to boost efficiency. The section on the Light Seeker robot contains a section dedicated to this subject. The program is simple but sloppy and performs a task with many degrees of freedom. Can you create a program that is more optimal?

At any stage, feel free to make modifications and improvements. Or use an idea or part of a project to jumpstart your own projects, which may be totally different from what you see here – that's what good engineering is all about.

This guide is mainly intended for building, so the explanations tend to be brief. We have prepared another document, *Vex™ for the Technically Challenged*, which concentrates more on theory and is occasionally referenced in this guide. The most current version is posted at:

<http://www.vexrobotics.com/vex-education-general-resources.shtml>

2009 Update

In November 2008, the Vex Starter Kit (Vex Robotics Design System v .5) was discontinued after nearly 4 years of successful sales. The Starter Kit is listed under "Kits Required" throughout the manual, and it can still be purchased on eBay. In its place, the Protobot Kit, in conjunction with the option of several Starter Bundles was offered. The Protobot bundles have some advantages over the original Starter Kit – they have fewer pieces that require cutting, and the extra wheels and motors provide more options for simple changes to the chassis and manipulators. The original Starter Kit had only building instructions for only one model and could not be easily modified by novices; however, it contained many pieces that were beneficial to advanced users, but using these pieces effectively required purchase of additional items.

If you plan to use the building instructions in this manual, you can assume that the Starter Kit can be replaced by one of the Protobot Bundles, plus one Metal and Hardware Kit. The Radio Control Starter Bundle (plus Metal & Hardware) replaces the Starter Kit in projects using R/C only – this includes all projects in the Part I, as well as the Tricycle Drive, Cup Crusher, and Chin-upbot. The Autonomous Control Bundle (plus Metal and Hardware) includes the Programming Kit and is sufficient for most of the projects in Part II (except the Boomerang). The Boomerang, the Holonomic Drive, and the Candy Sorter require the Dual Control Bundle, which will also allow you to build all R/C and Autonomous projects. If you purchase one of the larger bundles containing more structural metal, such as the Booster Kit or the Classroom Lab Kit, it is not necessary to purchase the Hardware and Metal Kit separately. In our opinion, the Classroom Lab Kit is the most versatile set and best value of parts for the money.

One huge monkey wrench to be thrown into the works in Fall 2009 is the anticipated release of the Vexnet 2.0 system. This is a major upgrade on the v0.5 controller and will include WiFi capability. It will probably be expensive -- speculative projections by users (not official suppliers) are estimating prices in the \$400 - \$500 range. This includes the control system only (it replaces the microcontroller and transmitters only) and does not include motors, metal, or mechanical parts, which will be compatible with both the old and new systems. If you already own an old v0.5 control system, you can purchase the Vexnet Upgrade Bundle (now available) for \$150. This plug-in will add Wi-Fi capability, but will not have the major upgrades of the 2.0 system (such as expansion from 8 motor ports to 16).

If you are a hobbyist, the Protobot bundles or old Starter Kit will probably be fine. However, if you plan to take part in a Vex competition you will probably need the Vexnet with WiFi to be competition compliant.

For more details regarding currently available kits, see *Appendix A: Recommendations for Kit Purchase (Summer 2009)*.

Part I: Beginning Mechanical Projects

There are many cool Vex™ designs on the Internet (check out the photo gallery at www.vexrobotics.com), but Murphy's Law dictates that you probably won't have enough parts to build most of them. Vex™ Starter Kits (the primary kit sold before 2009) and Starter Bundles (currently offered) seem to undergo 2 common fates: they grow and multiply, bringing delight to their owners (while simultaneously emptying the owner's wallet), or they occupy closet space, virtually untouched, until they eventually end up on e-Bay. In particular, people who have used a simpler "stand-alone" system like LEGO™ Mindstorms are sometimes surprised and disappointed by how little they initially are able to do with a Starter Kit or Bundle. The payoff with Vex™ comes later rather than sooner – with 8 motor ports and 16 sensor ports (vs. 3 motor and 4 sensor ports for LEGO™ Mindstorms NXT), an incredible level of complexity can be reached IF you're willing to spend the money and the time.

Alas, big IF! To be used effectively, a Vex™ Starter Kit or Bundle will need to be added to at some point, but there are still a few fun things that you can build with minimal parts. If you are fortunate enough to have acquired a Starter Kit before it was discontinued, you will have all the parts needed to build all the projects in this section. If you have a Starter Bundle, the addition of a Metal and Hardware Kit will provide all extra parts needed for the projects in this section.

Hopefully, with a few projects under your belt, you can make a better decision about whether to and what to invest in.



Basicbot

Project Description: Robust, highly maneuverable, 4-wheel drive robot. This is a simpler version of the Squarebot, which was documented in the first version of the Vex™ Inventors' Guide.

Kits Needed: 1 Vex™ Starter Kit
OR
1 Starter Bundle with Radio Control
OR
1 Classroom Lab Kit

Cut Pieces Needed: none

Bill of Materials:

2 large (60-tooth) gears 4 medium (36-tooth) gears 2 motor modules (NOT servo motors) 4 small wheels 1 microcontroller 1 RF receiver module 1 antenna sleeve holder (gray square part) 1 antenna sleeve holder (black tube part) 1 antenna sleeve 1 battery pack (7.2 v)	4 chassis rails 4 chassis bumpers 4 square bars (axles), 3-inch 2 square bars (axles), 2-inch 12 bearing flats 14 collars 6 large spacers 4 motor screws 36 keps nuts 36 medium length screws (3/8", 1/2" or 5/8")
	

Build Sequence:

Attach 2 bearing flats to the middle row of a chassis rail, 2 holes from each end, as shown.



In the same way, attach bearing flats to 3 more chassis rails (to get 4 identical rails).



Flip 2 chassis rails over and attach a bearing block to the back of each rail, middle row in the 3 center holes as shown. Set aside these 2 rails for now.

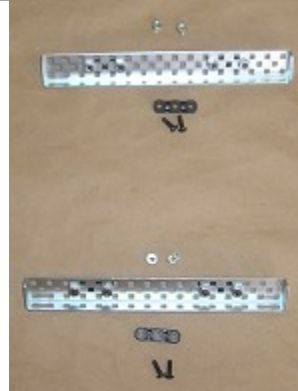

On the other 2 rails, attach a motor to each rail using motor screws. Place the motor on the inside of the rail and the bearing flat on the outside of the rail. On one rail, the motor should be immediately next to the left bearing block; on the other rail, it should be immediately next to the right bearing block (the 2 rails should be mirror-image reflections of each other, not identical copies).

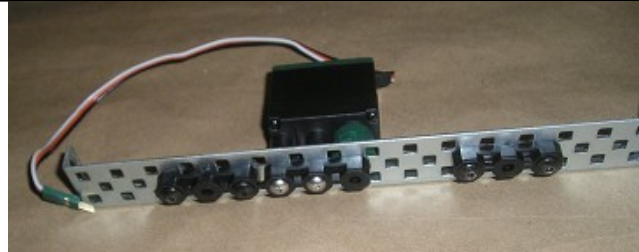
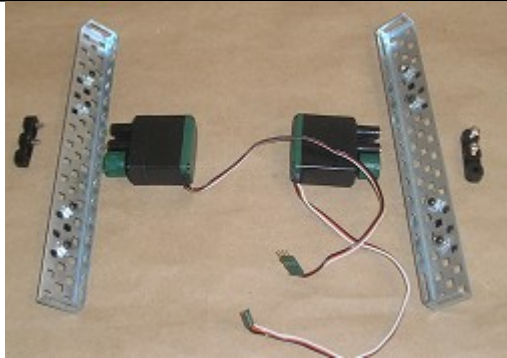

Insert a 2-inch axle into each motor as far as it will go and anchor with a collar.

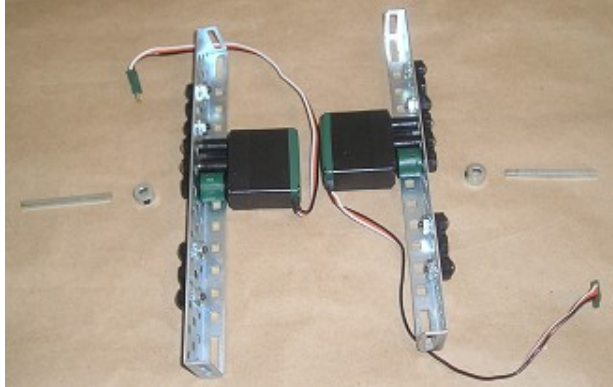

Insert 3-inch axles through each of the bearing block holes.

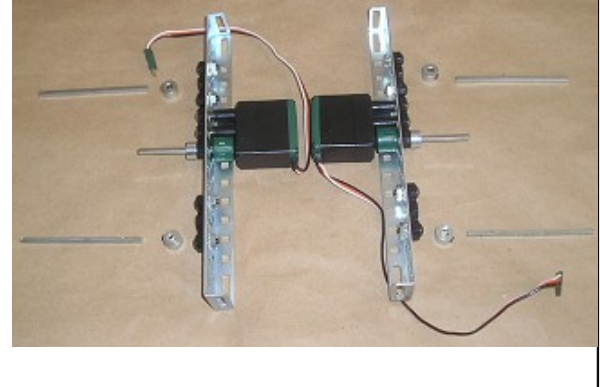

Anchor each of the axles with a collar on the outside. The axle should extend through the bearing block and rail, but should extend as little as possible past the inside of the rail.

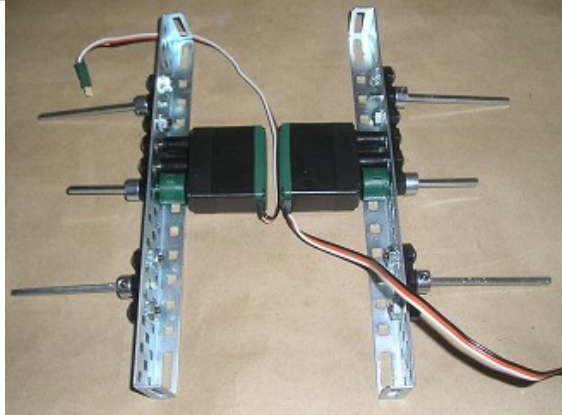

Slide large gears onto the 2 motor axles. Slide medium gears onto the 4 corner axles.

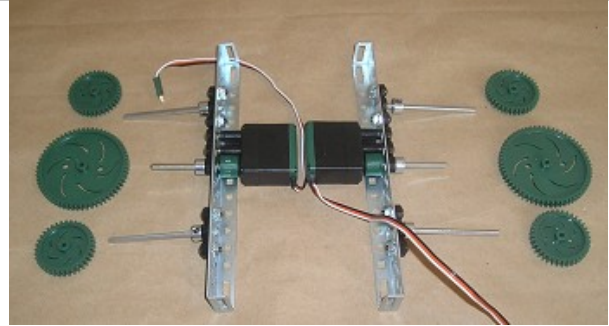

Slide 4 collars onto the 4 corner axles (do NOT put a collar on the motor axles).

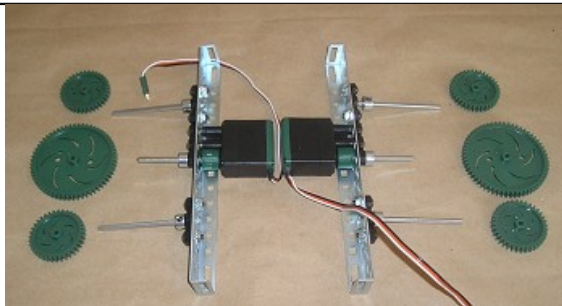

Slide large spacers onto each of the 6 axles. Slide the 2 chassis rails (previously set aside) onto the axles – the holes should line up. Be sure the chassis rails are all oriented with hole strips down and thin edge facing up.

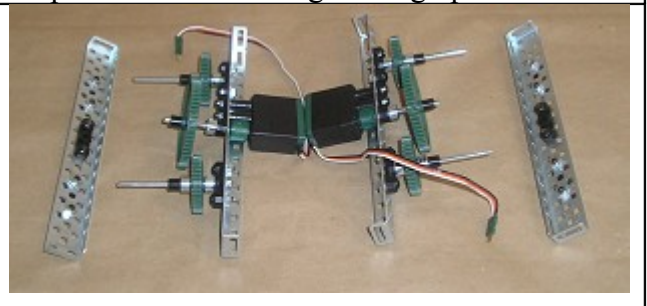

Attach the 4 rails to chassis bumpers in the front and back. Line up the gears and collars so that they fit snugly and evenly. Tighten collars.

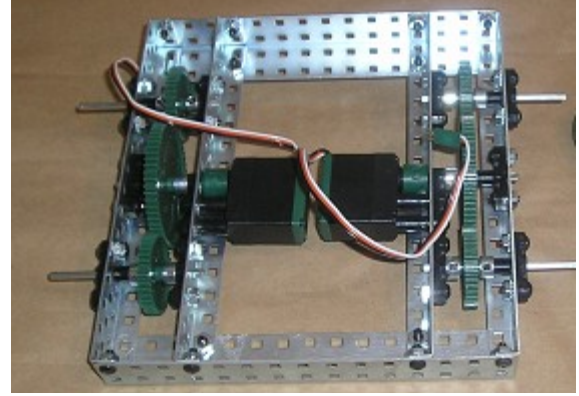
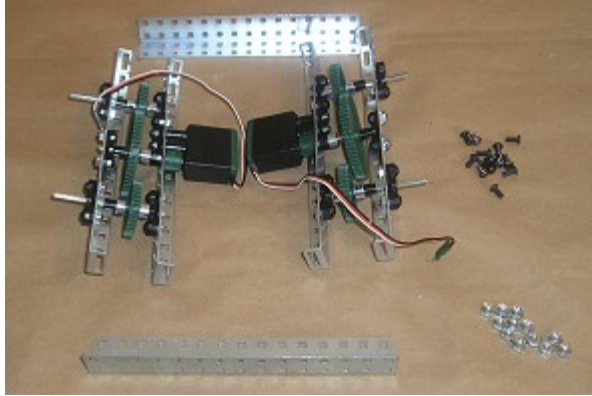

Turn over chassis and anchor top side of the chassis bumpers in 4 (or 8) places.

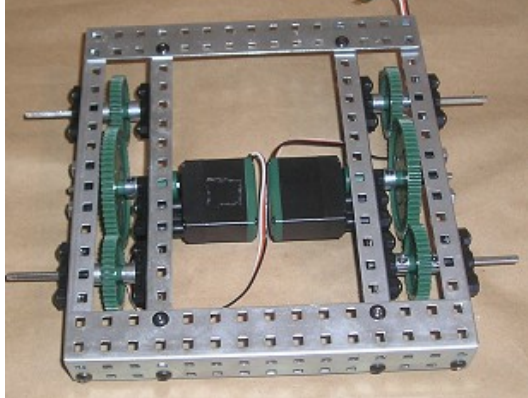

Slide wheels onto each axle and anchor with collars. Attach the microcontroller on top

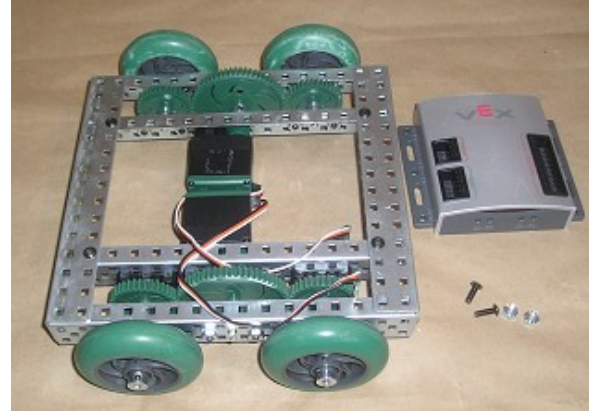

Plug motors into Motor Ports 2 and 3. Attach RF module to chassis and plug into RX 1 or RX 2 on microcontroller. Slide RF antenna through sleeve, and black tube over sleeve. Attach the gray antenna sleeve holder to chassis, and mount black tube on holder, bending antenna through slot. Attach battery using battery strap or tape (the lazy way!).

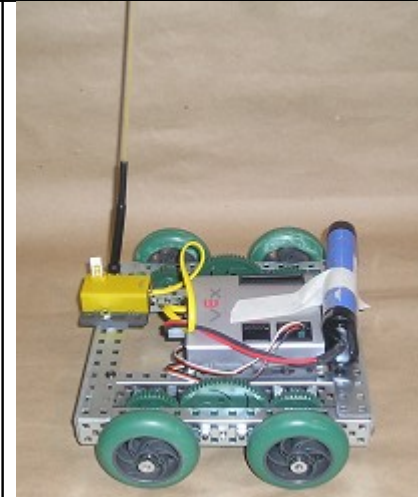
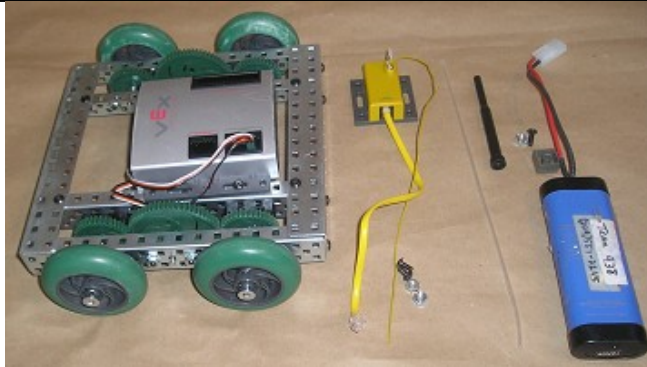

Project Notes and Engineering Principles:

Gearing and Direction of Motion

The Basicbot has 3 gears on each side. Watch how the motor *drives* the center gear, and the 2 side gears are *driven*. These wheels will turn in the directions as shown below:

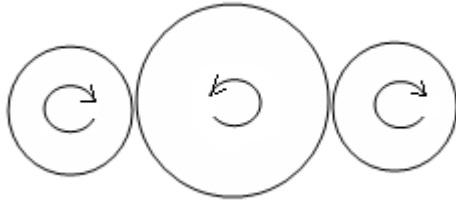

Note that the direction of rotation alternates back and forth from one gear to the next. Thus, gears with an odd number of gears in between (like the 2 end gears shown above, with 1 gear between) will turn in the same direction, while gears with an even number of gears between (including 0) will turn in opposite directions.

Drive Trains (Four-Wheel Drive)

Note that each of the 2 motors on each side causes 2 wheels to turn, making this a 4-wheel drive robot. As a result, the Basicbot is highly maneuverable – it gets good traction and is easily controlled. It is also relatively fast because of its geared-up configuration (more on that in the next project). Two-wheel and 6-wheel drive are also commonly used. There are other types of drive trains which allow wheels to operate independently of each other or the chassis, including holonomic drives and swerve drives.

Flexigearbot

Project Description: A 2-wheel drive robot whose main design feature is the easy exchange of gears. It converts from geared up to geared down to geared with a 1:1 ratio in under 5 minutes.

Kits Needed: 1 Vex Starter Kit
OR
1 Starter Bundle with Radio Control, plus 1 Square Bar, 6 " or 12"
OR
1 Classroom Lab Kit

Cut Pieces Needed:

1 square bar (axle), 6" (optional – a 12" axle can be used if you wish to keep the 12" axle uncut for other projects)

Bill of Materials

1 microcontroller	1 metal plate (5" X 15")
1 RF receiver module	1 chassis bumper
1 antenna sleeve holder (gray square part)	4 chassis rails
1 antenna sleeve holder (black tube part)	1 long square bar (6" preferred, but 12" OK)
1 antenna sleeve	4 square bars (3")
2 motor modules (NOT servo motors)	36 keps nuts
1 battery pack (7.2 v)	6 small plastic spacers (.182)
2 small wheels (with rubber tires)	10 bearing flats
1 small wheel hub (rubber removed)	14 collars
2 large (60-tooth) gears	4 small motor screws (1/4")
2 small (12-tooth) gears	32 medium length screws (3/8" or 1/2" or 5/8" – use 3/8" in tight corners)
4 medium (36 tooth) gears	4 long screws (3/4")

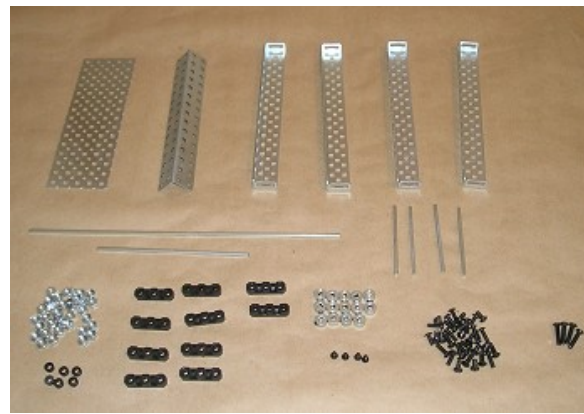
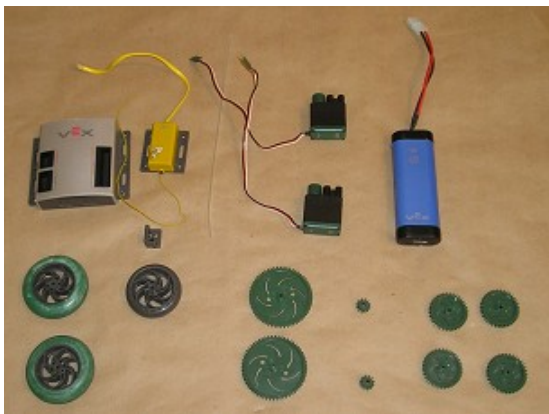

Build Sequence

Attach bearing flats to the chassis rails as shown. The center pair of flats is attached to the middle row of holes, closest to the edge with screws facing up. The outer pair of flats is located in the last row, offset 3 holes from the edge with screws face down. The rails are mirror-image symmetrical, not identical.



Attach a chassis bumper to the ends nearest the bearing flats offset by 3 holes.

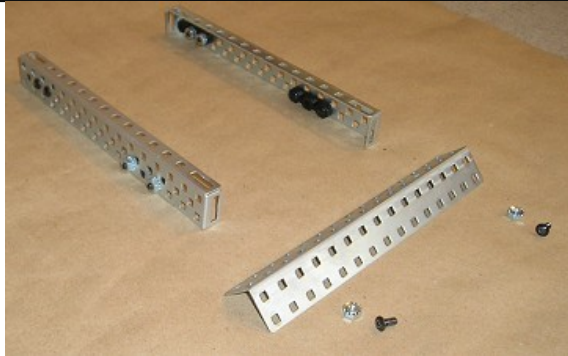

Attach a metal plate to the chassis rails as shown.

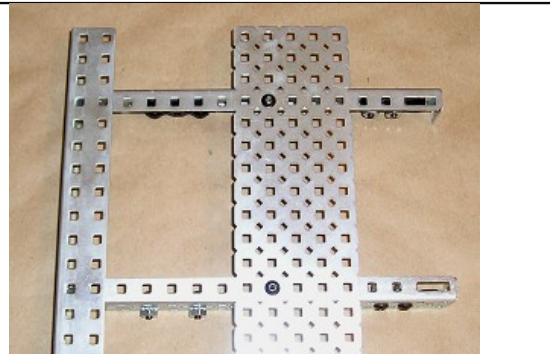
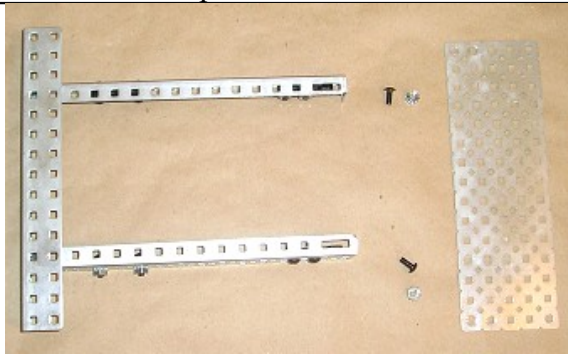

Turn the chassis upside down and attach motors on the inside of the rails.

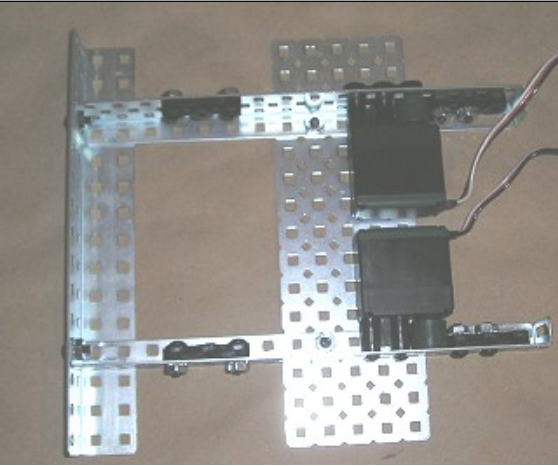
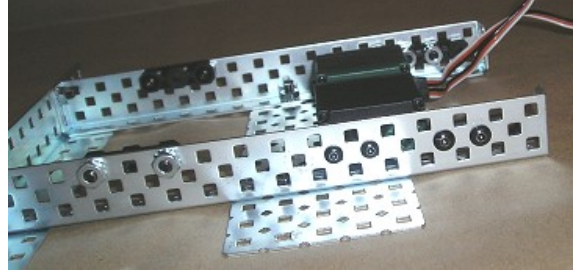
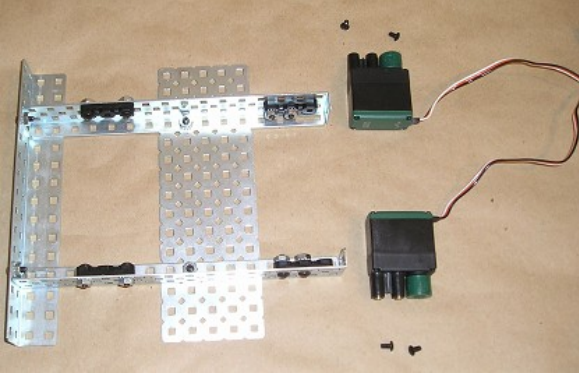

Attach bearing flats to 2 additional chassis rails as shown.

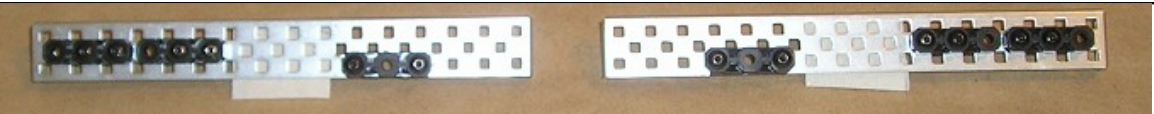
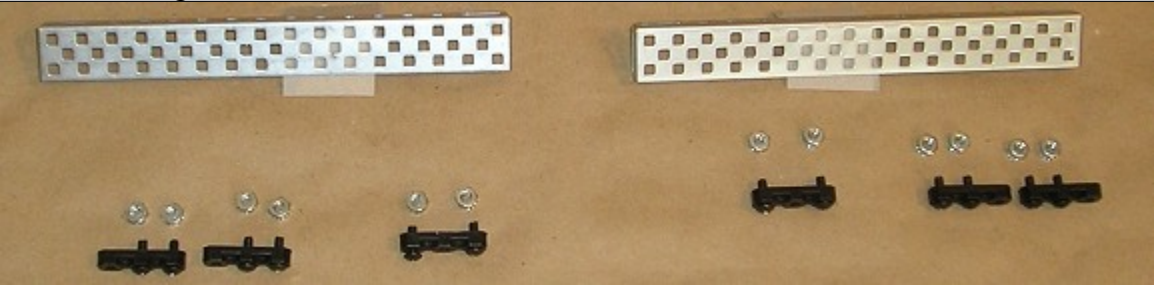

Turn the chassis right-side up and attach the 2 outer rails.

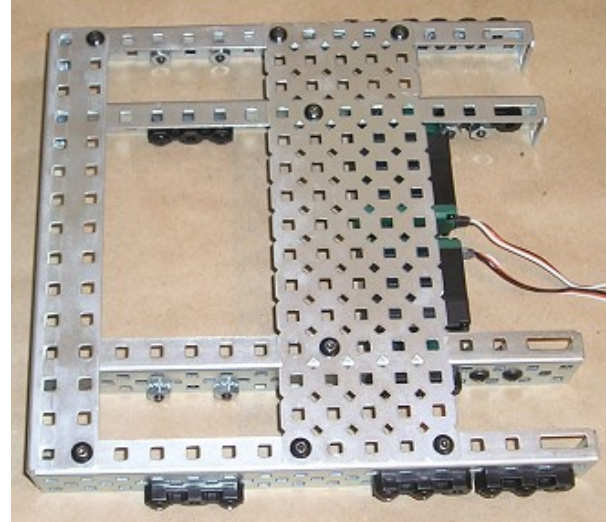
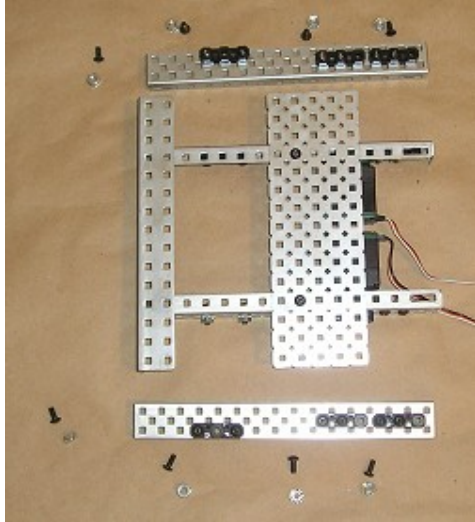

Insert 3-inch axles into the motors and anchor with a collar from inside the chassis.

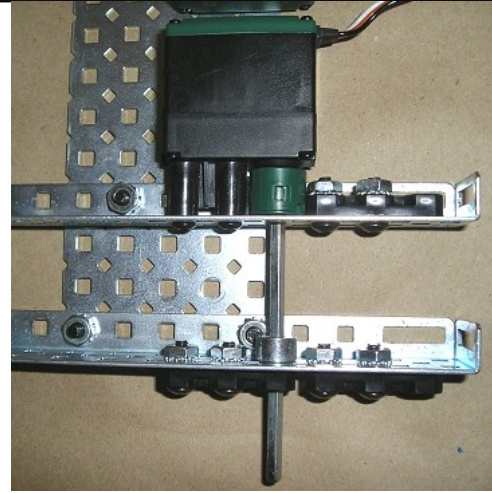
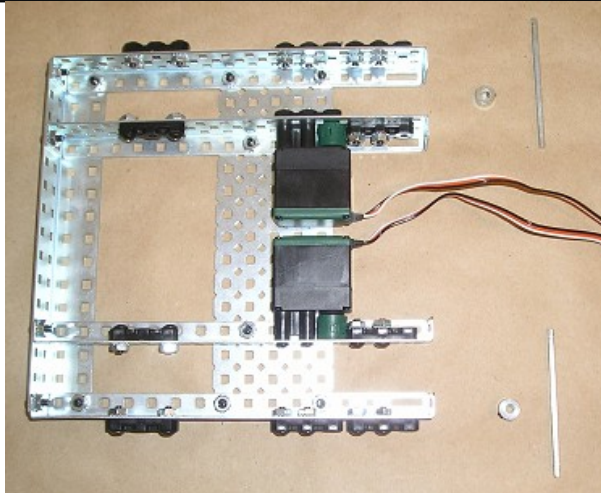

Attach the wheels, using 2-inch axles. Anchor with 2 collars outside and 1 small spacer on the inside of the wheel.

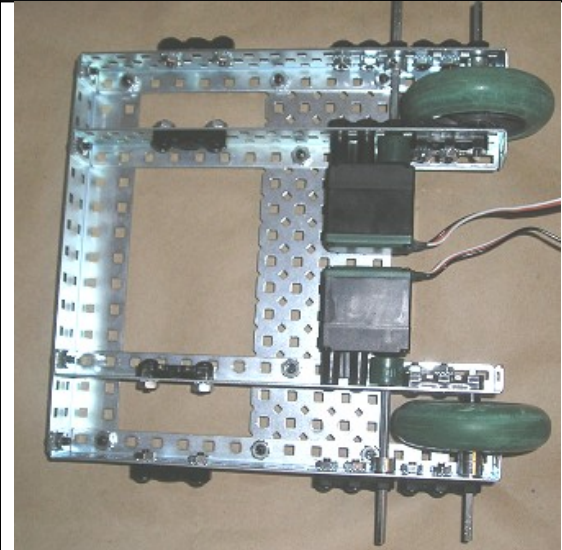
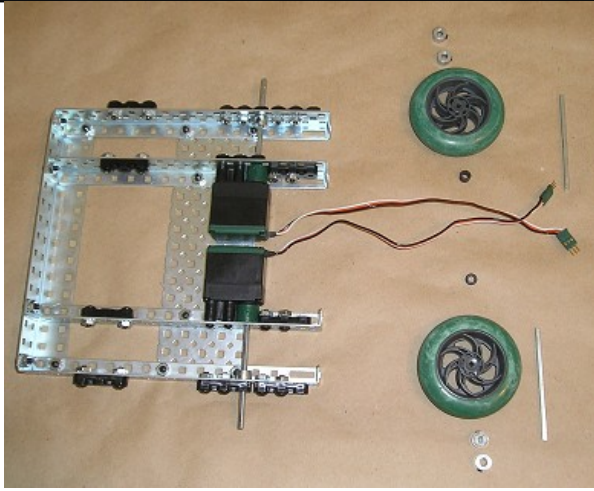

Attach the gears, anchoring with collars on the outside. This configuration (small gear driving a large gear) is geared down.

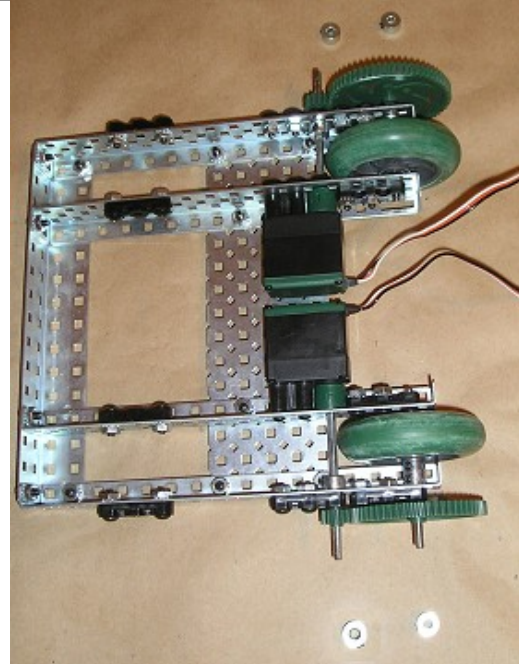
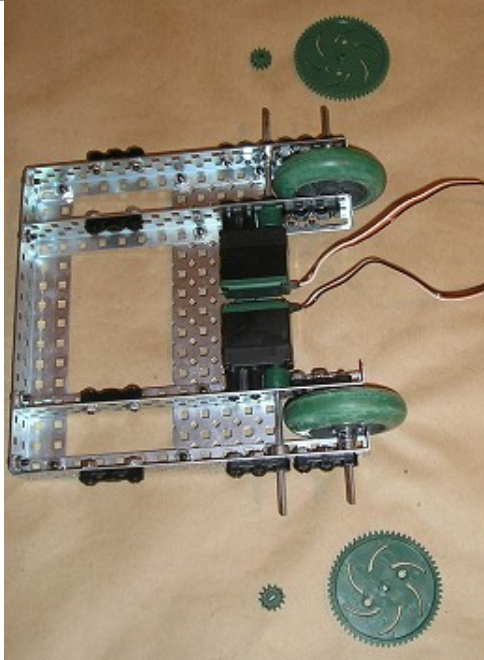

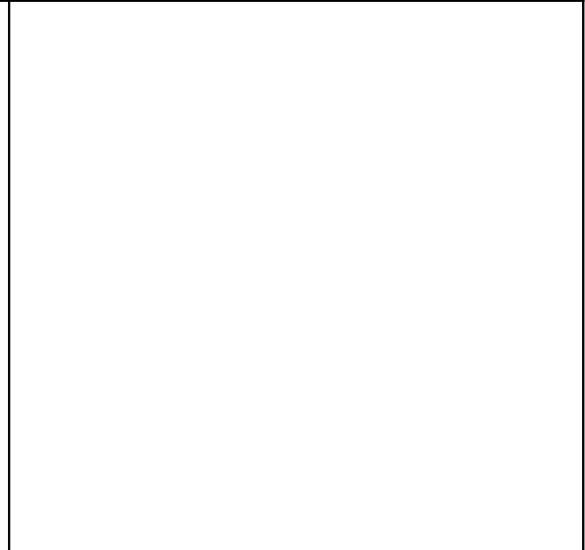
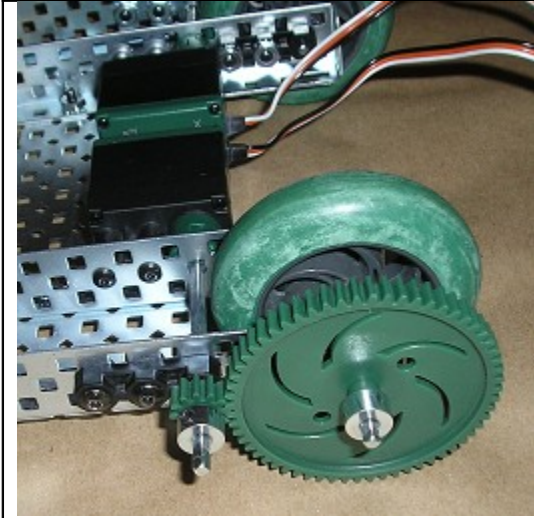

Attach the castor wheel, anchoring with collars next to the wheel and inner rails. The 6-inch axle is preferred (making the outer bearing flats extraneous), but a 12-inch axle may be used if desired to avoid cutting.

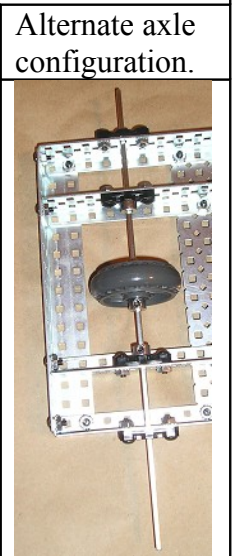

Attach microcontroller, RF module, antenna, and battery. Plug motor wires into motor ports 2 & 3, using Channels 2 & 3 (forward and reverse joysticks) on the transmitter. Let 'er rip!

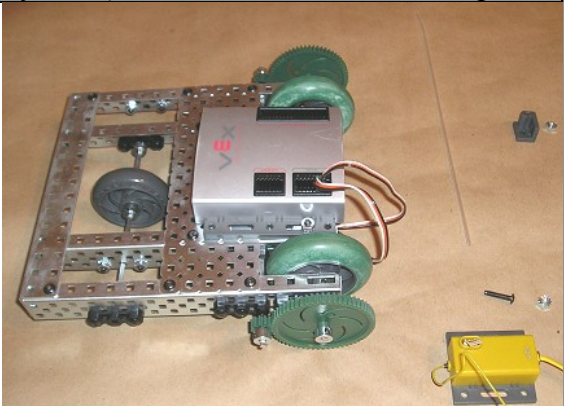

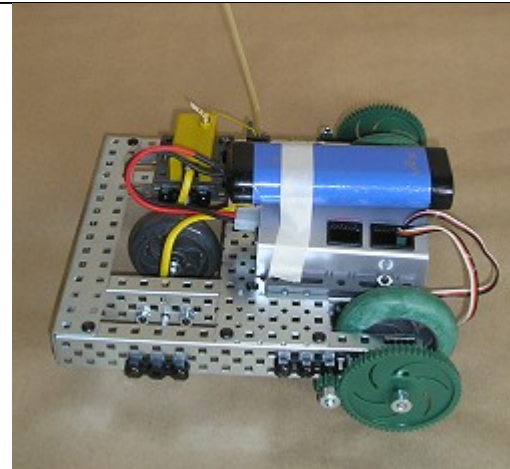
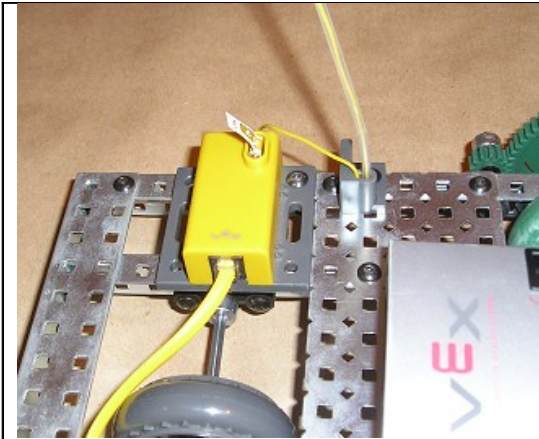

Alternate configurations:

Exchange the gears for a geared-up bot.

Replace the large and small gears with 2 medium-sized gears for 1:1 gearing.

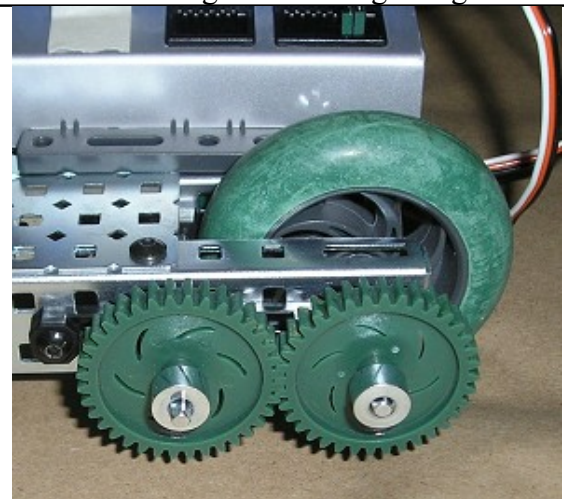

Project Notes and Engineering Principles

Gear Ratios

The speed of a robot largely depends on 1) how fast the motors are turning, 2) the size of the wheels, and 3) the gear ratio connecting the driving motor to the driven wheels. To better visualize the role of gear ratios, suppose a motor is connected to an axle which turns a 60-tooth (large) gear. A single rotation moves this gear through 60 teeth. If this gear is coupled with a 12-tooth gear, one rotation will drive the small gear through 60 teeth. However, since only 12 teeth are needed to produce a single rotation of the small gear, this gear will make 5 complete rotations every time the large gear turns once. This means that the wheel will rotate 5 times as fast as the motor. Causing the driven axle to move faster than the drive axle is called *gearing up*. While going faster may seem like a good thing, you can't get something for nothing, and what is gained in speed is lost in *torque*, or strength of turning.

The Flexigearbot has 3 configurations: geared up, geared down, and geared in a 1:1 (same) ratio. Try all 3 and test your robots for different parameters such as speed, ability to climb a slope, ease of turning around obstacles, and effectiveness on different surfaces, like tile, carpet, and gravel.

One factor that biases the outcome should be noted: the large gears are almost the same size as the small wheels, and if the gears touch the ground (likely to happen on soft, uneven surfaces like carpet), the friction will work against the wheel motion or with it. When geared up, the gears oppose the wheel motion; when geared down, they assist it.

Quiz question: What type of gearing does the Basicbot use?

Two-Wheel Drive

This robot has 2 powered wheels and a "dead" castor wheel. Not surprisingly, 2-wheel drive robots are often called castorbots. Castors may also be pivoting castors, like those on a swivel chair, or they may simply be a low-friction object that drags on the ground (sometimes called a *skid*). Rubberless wheels, omniwheels, and bearing blocks are often used for castors. Because of the lack of traction, castorbots tend to be more difficult to maneuver than 4-wheel drive robots.

Ping Pong Shooter

Design and Build: Yolande Petersen and Ryan Chambers

Project Description: Mechanism which shoots ping pong balls up to 5 feet (easy project!)

Kits Needed: 1 Vex Starter Kit

OR

1 Protobot Bundle with Radio Control

OR

Cut Pieces Needed: None

Bill of Materials:

1 microcontroller 1 battery 1 RF receiver 1 motor 2 motor screws 4 threaded beams, 1/2 " 2 threaded beams, 2" 1 chassis rail 1 plate 5 X 15 holes 2 large gears (60-tooth) 2 square bars (axles), 3"	4 bearing flats 6 keps nuts 4 small screws (1/4") 6 medium screws (3/8" or 1/2 ") 2 collars 4 large spacers 4 small spacers 2 intake rollers
--	---



Build Sequence:

Attach motor to middle row of chassis rail.

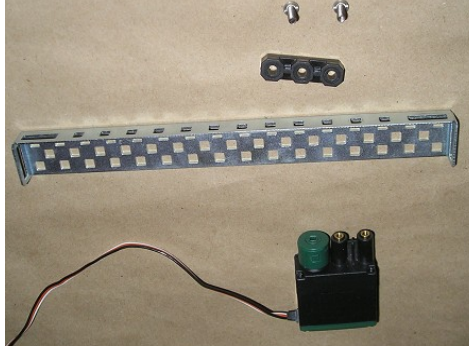

Attach bearing flat to the inside of chassis rail, leaving the middle hole empty.

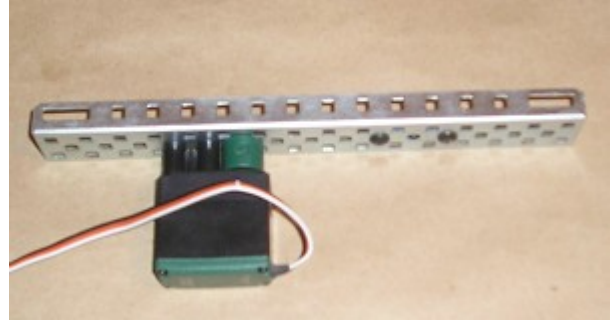
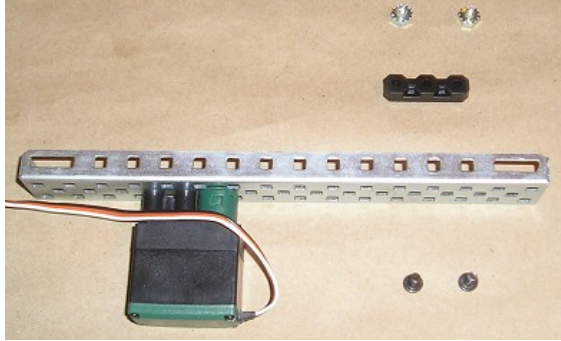

Attach threaded beams to chassis rail in the middle row

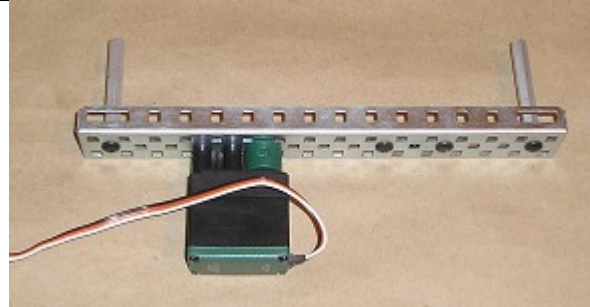
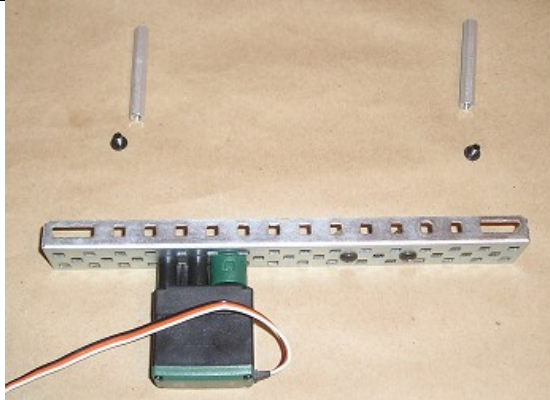

Insert axle into motor. Anchor one end of second axle and feed it through bearing flat.

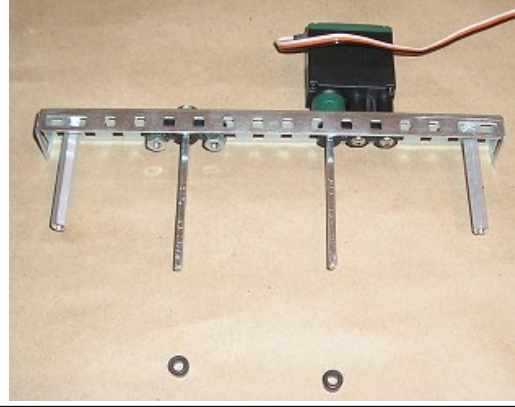
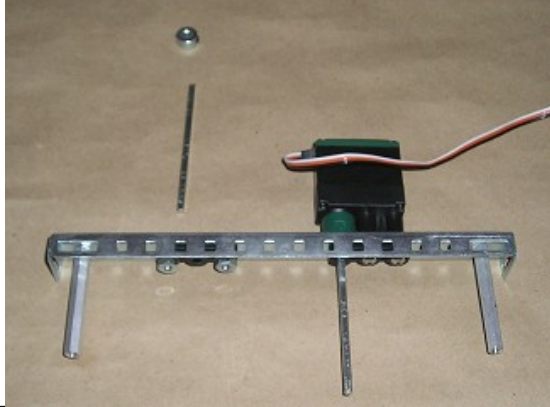

Attach gears to axles. Add one large and one small spacer to each axle.

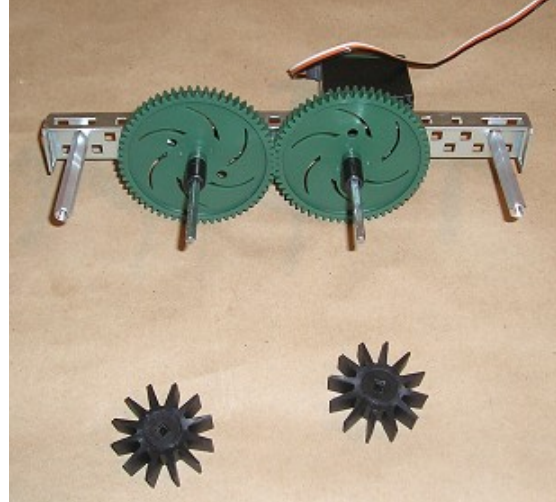
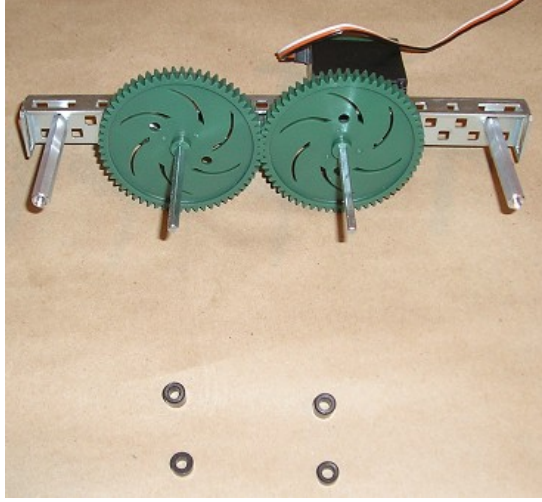

Add an intake roller and large spacer to each axle

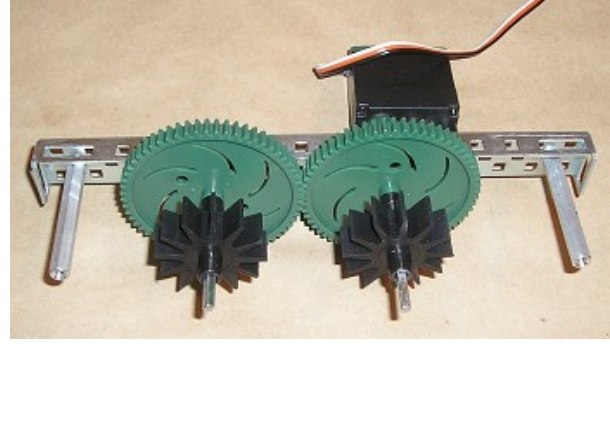
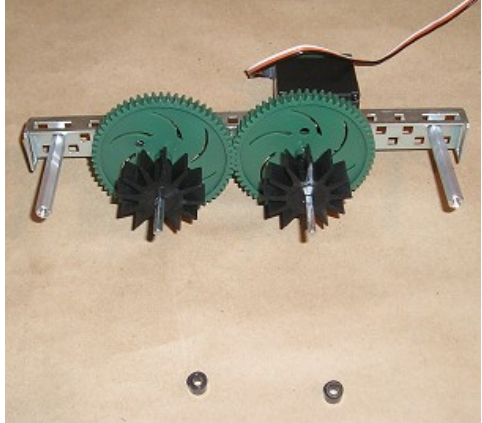

Attach 2 bearing flats to the middle row of the plate as shown. Hole positions will correspond to the axle positions.

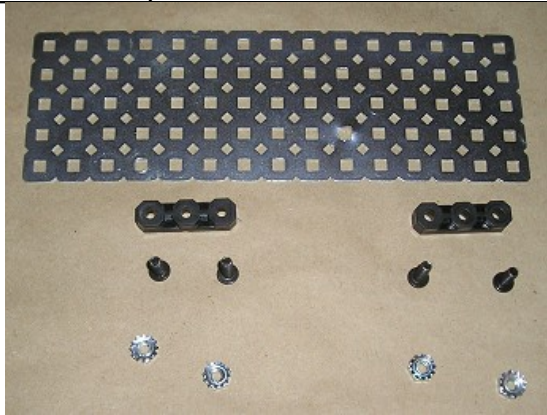

Feed the 2 long screws through the plate, then screw on $\frac{1}{2}$ " threaded beams until the screws are flush with the beams.

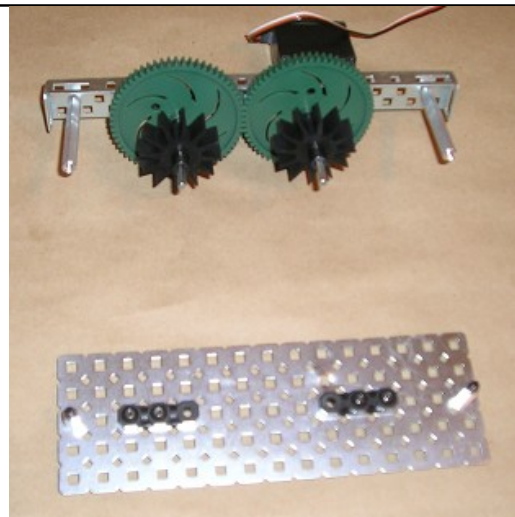
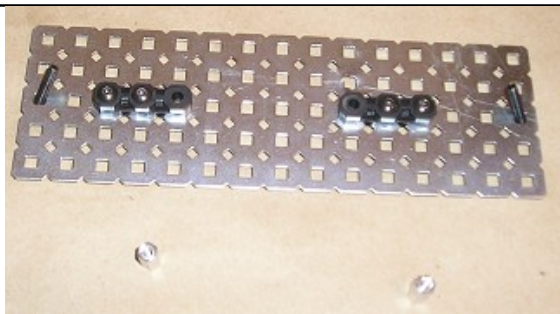

Join the $\frac{1}{2}$ " and 3" threaded beams by screwing the rest of the long screws into the 3" beams. Anchor the non-motor axle with a collar.

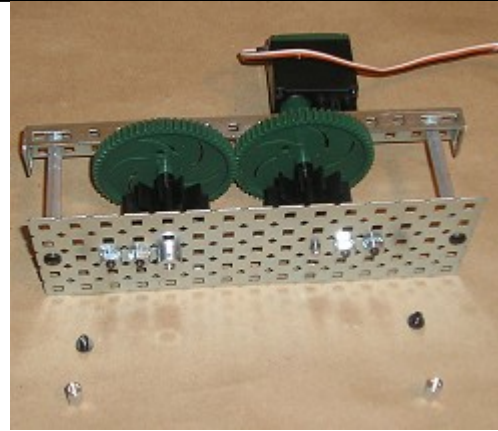
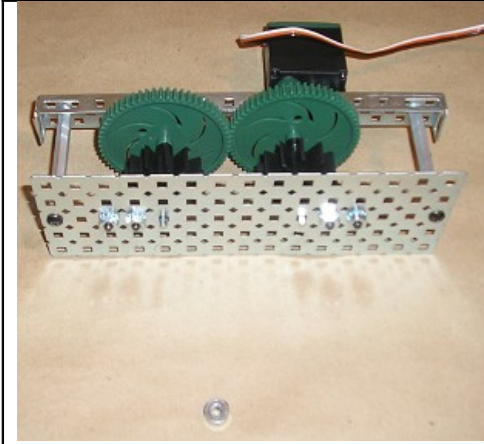

Attach ½" threaded beams to the bottom. These lift the front of the device, providing a bit of a ramp for the balls to launch. Turn the device right-side up, and feed the ping pong balls from the bottom of the ramp into the intake device. Attach battery, RF receiver and motor wire to microcontroller (e.g. to motor port 3), using the joystick (channel 3) to activate the motor. Watch your fingers!

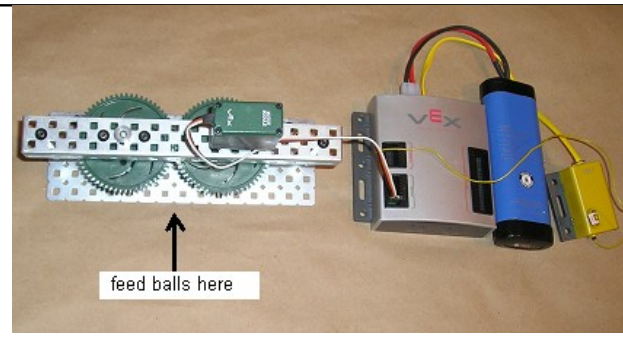
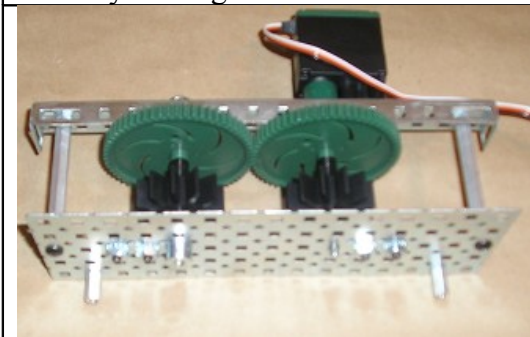

Project Notes and Engineering Principles

This project is fun and quick to build, but not particularly profound. It does demonstrate use of the intake rollers for grabbing, a common practice in competition when trying to score a large volume of objects, like balls or rings.

Animal Grabber – Part 1: The Gripper

Project Description: Mechanism which grabs and lifts squishy objects about 3-inches in diameter.

Kits Needed: 1 Vex Starter Kit (plus 1 extra plate 5 X 15 holes, if available)

Cut Pieces Needed:

2 long bars, 10 holes

2 long bars, 9 holes,

3 long bars, 6 holes (or slightly longer)

2 angle bars, 2 ½ "

(Note: one long bar, 25 holes cuts nicely into 10 + 9 + 6 holes)

Bill of Materials (for Parts 1 and 2)

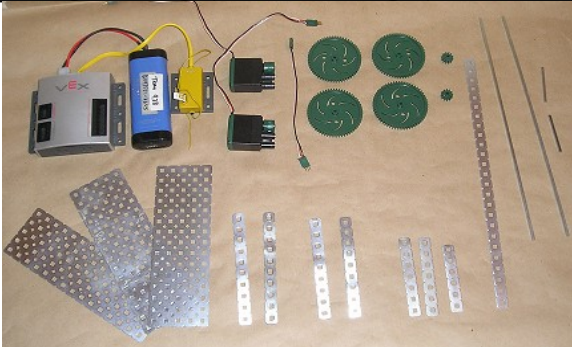
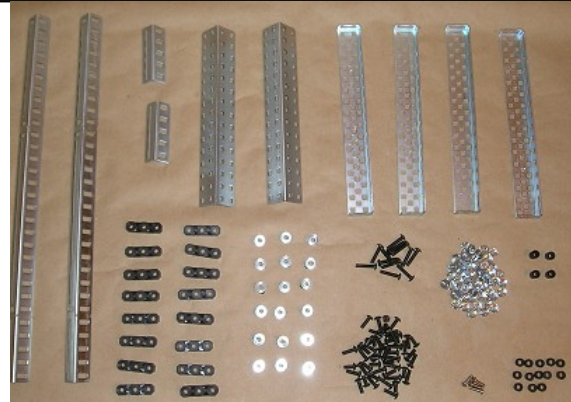
<ul style="list-style-type: none"> 1 microcontroller 1 RF receiver module 1 battery pack 2 motor module 1 PWM extension cable 4 large (60-tooth) gears 2 small (12-tooth) gears 2 square bars (12") 2 square bars (2") 2 or 3 plates (5"X15") – 3rd is optional 2 long bar strips (1 X 10 hole) 2 long bar strips (1 X 9 hole) 3 long bar strips (1 X 6 hole or longer) 1 long bar strip (1 X 15 or longer) 	<ul style="list-style-type: none"> 2 angle bars (15" or shorter) 2 angle bars (2 ½ ") 2 chassis bumpers 4 chassis rails 16 bearing flats 18 collars 12 long screws (3/4") 47 medium screws (3/8" or ½ ") 59 keps nuts 4 long motor screws 4 large spacers 13 small spacers
	

Build Sequence

Attach gears to 2½" angle bars, placing small spacers between gears and angle bars.

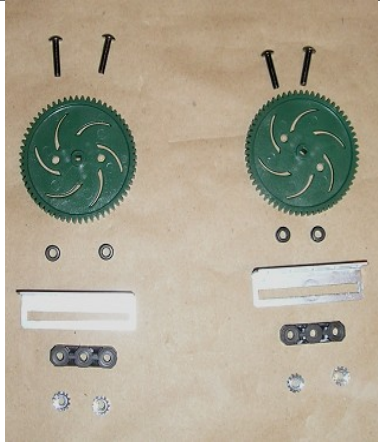

Attach 9-hole, then 10-hole strips to angle bars, separated by large spacers.

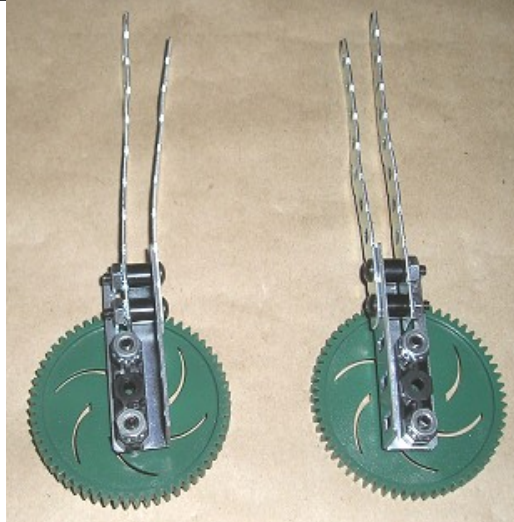
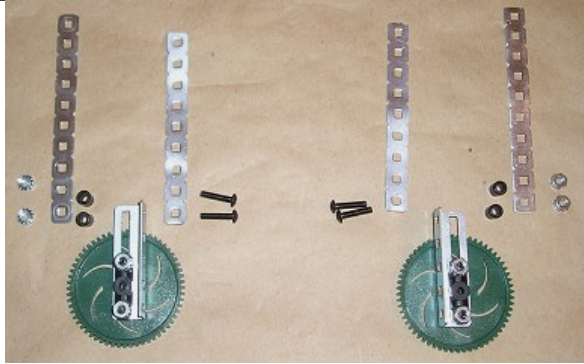

Bend strips until the ends meet, and attach the tips, separated by large spacers.

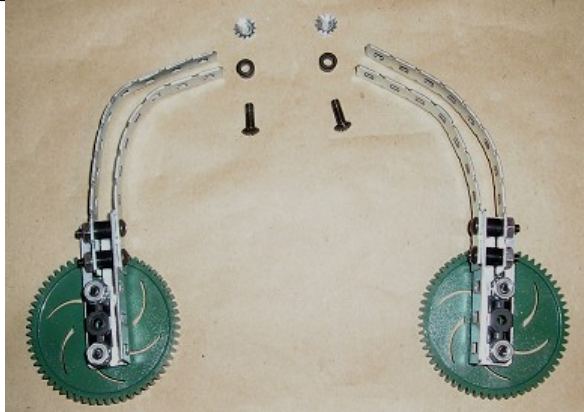

Attach bearing flats, motor, and "fingers." Nest gears so that the "fingertips" are more or less symmetrically placed. Note that it's useless to attach a collar to the motor axle, as this does not prevent the axle from falling out.

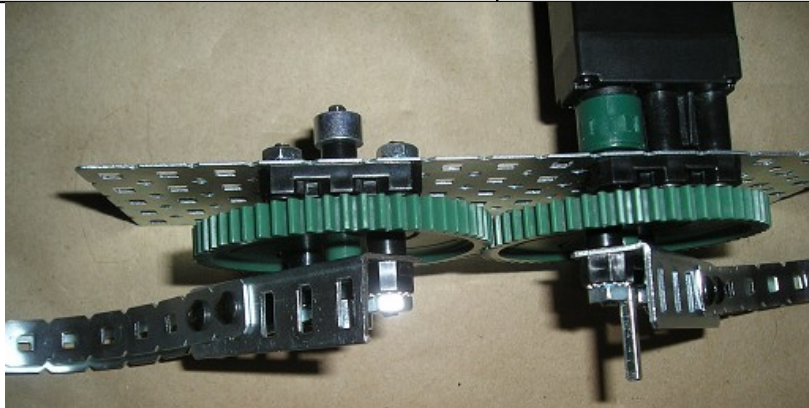
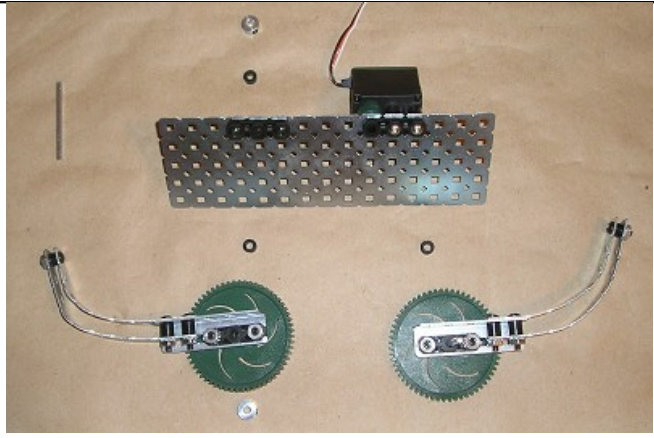
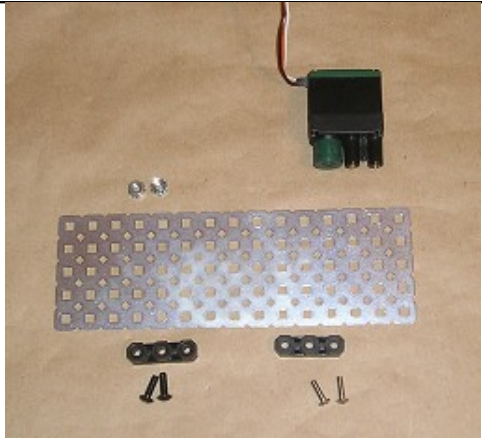

Attach motor to a microcontroller, battery pack, and RF module. You can now open and close the pinchers. They move fast, because they're not geared down.



Project Notes and Engineering Principles:

You may have seen machines where (for a "modest" fee), a claw will swoop down and attempt to grab and lift a stuffed animal from a pile. Unfortunately, there is strong motivation to use a poor design -- the worse the claw works, the more money it makes for the vendor! This project is capable of lifting a small stuffed animal. Because of its complexity, the project is divided into 2 parts: the gripper, and the lift.

Grippers (One-Axis Linear Grip)

Imagine grabbing an object, like a soda can, with only your thumb and forefinger. You would probably attempt to grab the can by either 1) pinching it with the tips of your fingers or 2) encircling it with the entire length of the arc formed by your thumb and forefinger. In the same way, a linear one-axis grip holds an object with either the tips of its arms or by encircling it with its arms, the way you would hold onto a very large beach ball. For round objects, the second method requires less force to hold an object, as the greater contact surface provides more friction. The first method also requires that the "finger tips" be positioned very precisely, but is better for picking up small, light objects of irregular shape.

To keep hold of the object, you have to continually keep the motor powered to apply continuous pressure, or the pinchers will "let go", even if they remain closed. For this reason, a continuous motor, rather than a servo (with motion limited to 120° of rotation) is used, as a servo is capable of closing on the object but unable to move beyond a certain point to apply the needed pressure. There are other gripper designs that keep holding on without continual powering from the motor. These include 2-axis grips, roller grips, and grips using *bi-stable* designs (having 2 stable positions: open and closed) such as those activated by rubber bands or pneumatics.

Animal Grabber – Part 2: The Lift

See Part 1 for Project Description, Kits Needed, Cut Pieces Needed, and Bill of Materials

Build Sequence:

Attach chassis bumpers for lift arms to the metal plate. Note that diagonal placement of the screws secures the bumpers in 2 dimensions with a minimum of 2 screws.

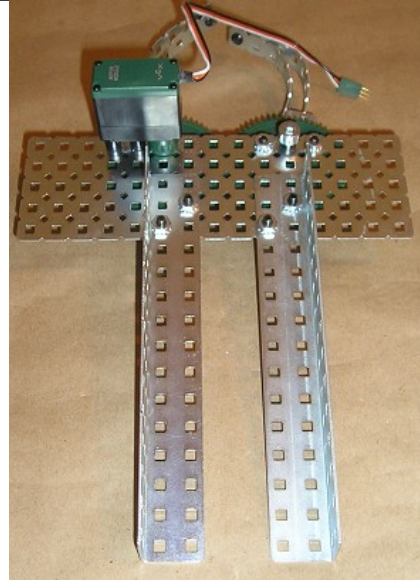
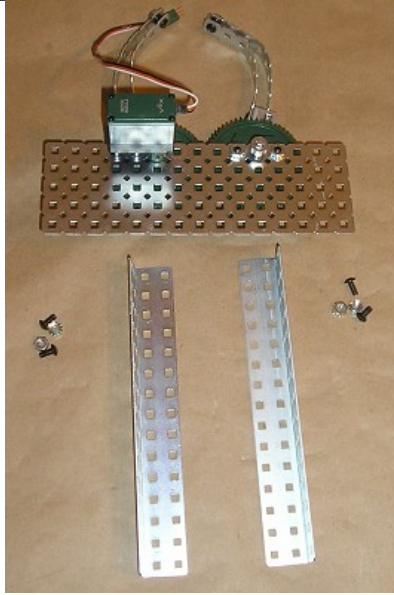

Attach gears to the end of the lift arm, using small spacers to reduce gear friction.

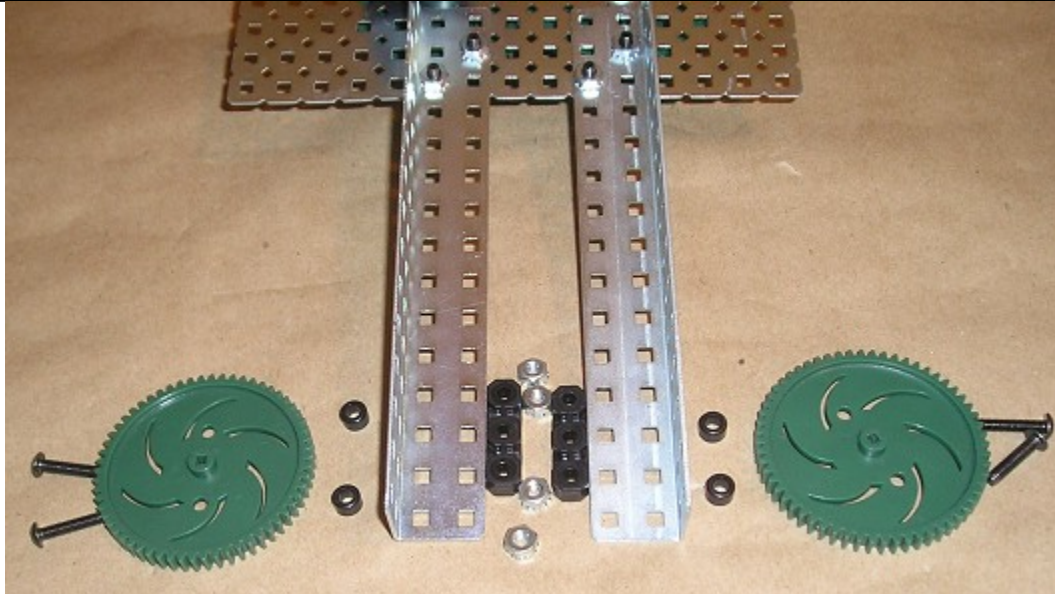

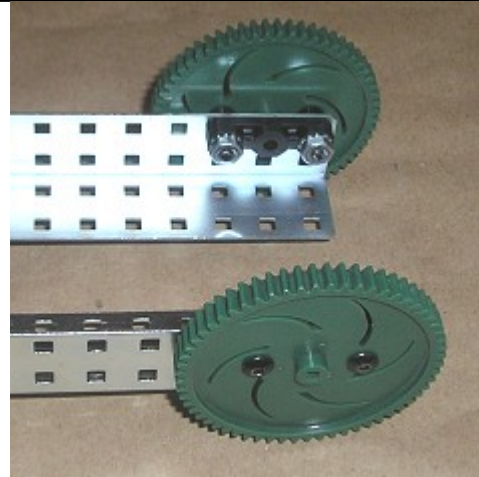
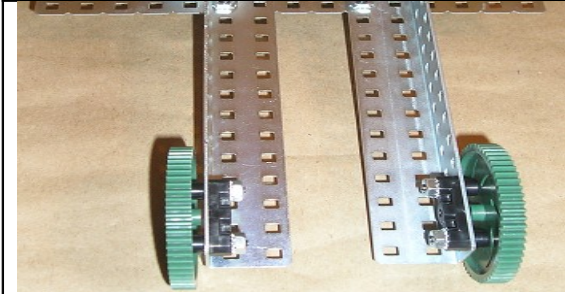

Build the base. Slightly shorter angle bars (e.g. 12 1/2" bars) also can be used for the base.

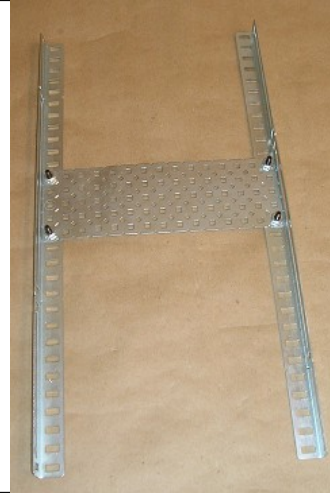
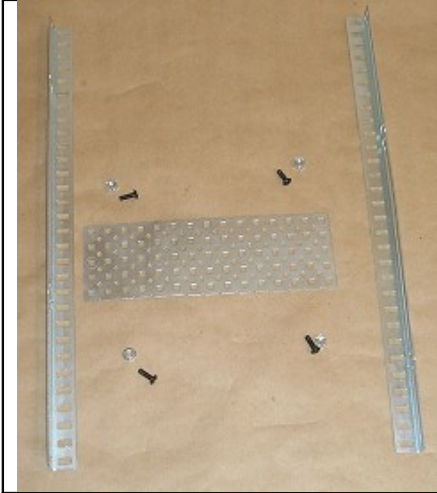

Assemble side supports, joining 2 chassis rails, and attaching bearing flats that will support the axles.

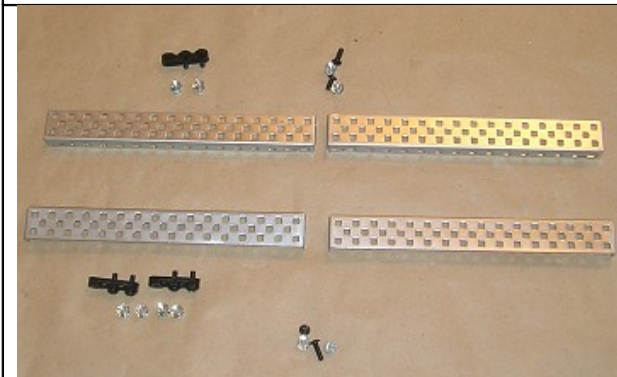

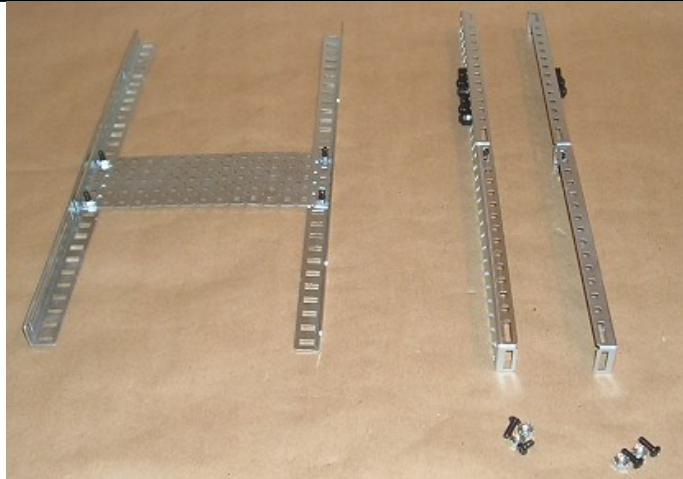
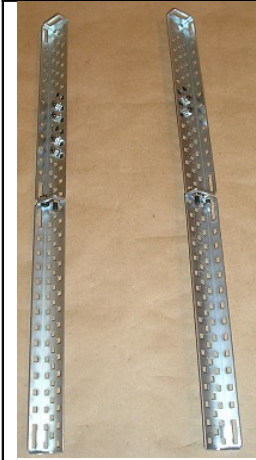

Attach supports across the top and back, a minimum of 15 holes. A long bar (or bars) can be substituted for the plate if necessary.



Assemble axle supports (ideally 6-hole bars, but slightly longer is OK).

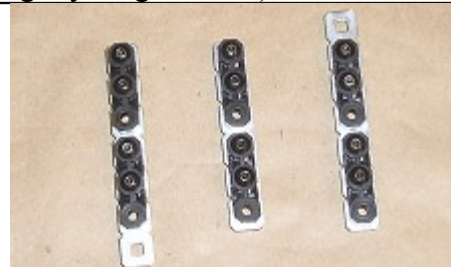

Attach the lift arm to the frame, inserting the 12" axle through the collars, supports, and gears in the order shown. Red lines indicate position of the frame.

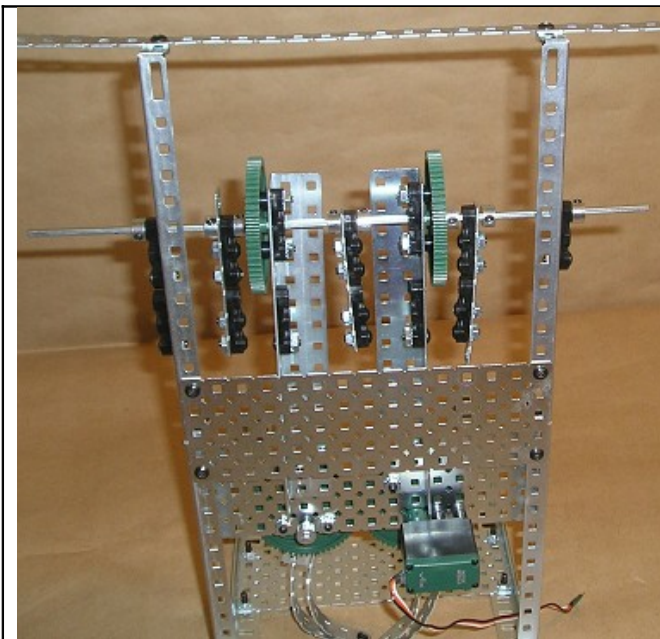
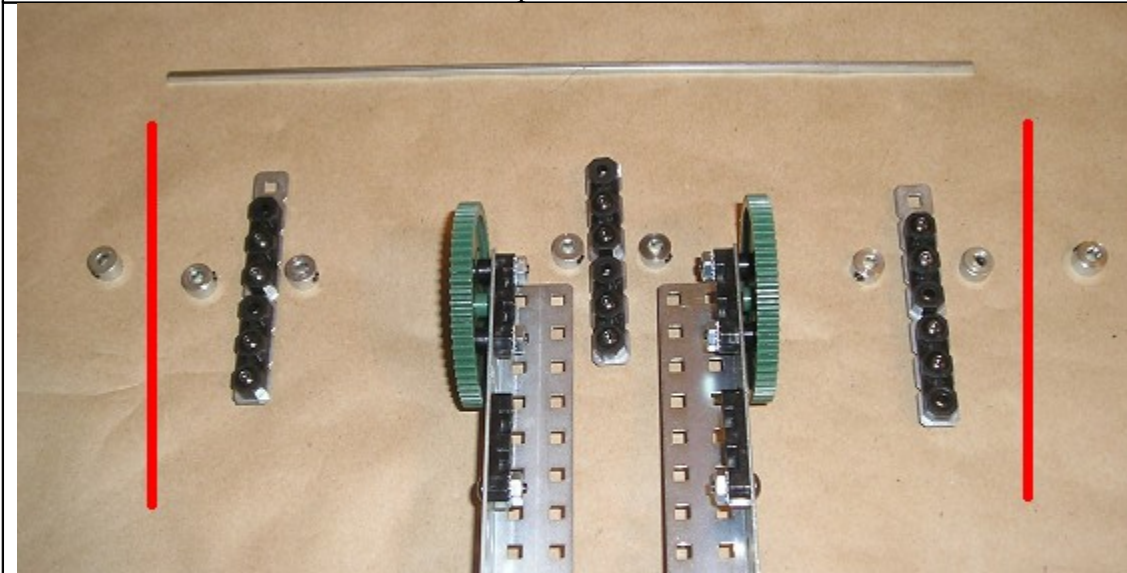

Attach motor below first axle, lining up holes for second axle.

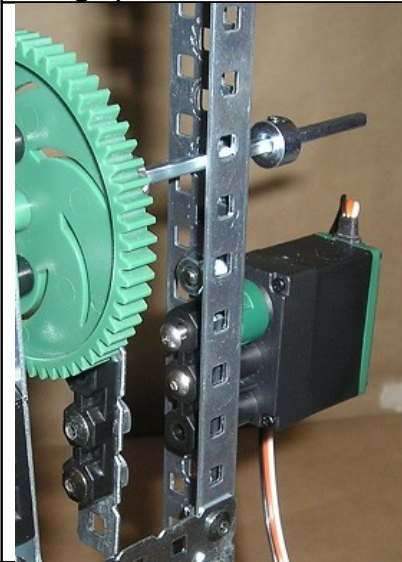

Insert the lower axle, attaching gears and collars in the order shown.



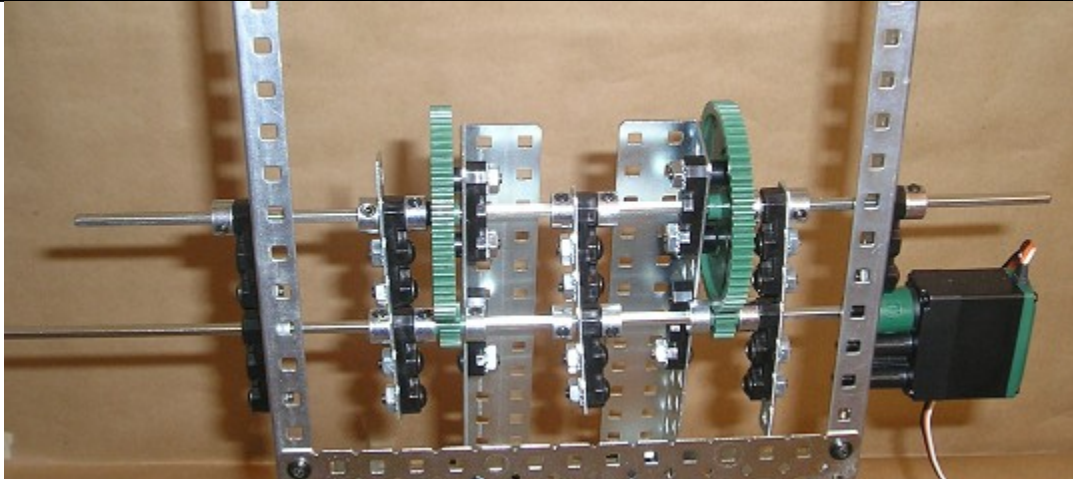

Plug the battery, RF module, and motors (ports 2 and 3) into the microcontroller. Because this model is non-mobile, placement is flexible. However, a PWM extension cable is needed for the gripper motor, as the motor wire is too short when the lift is fully extended.

Rear View

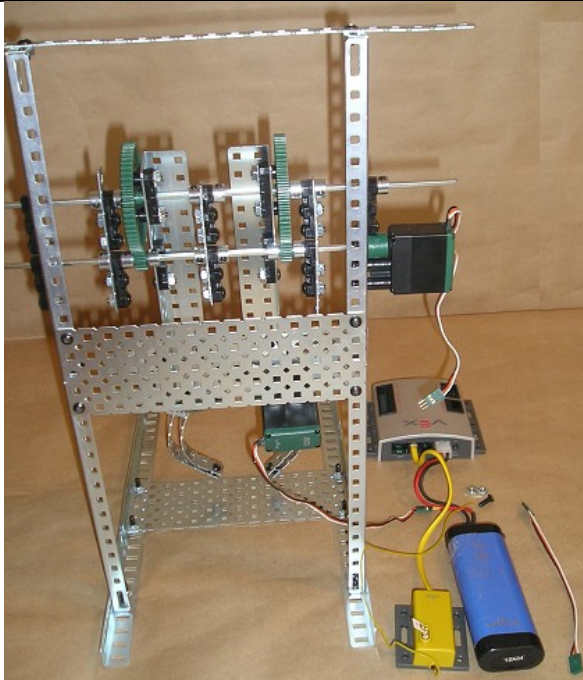

Front View

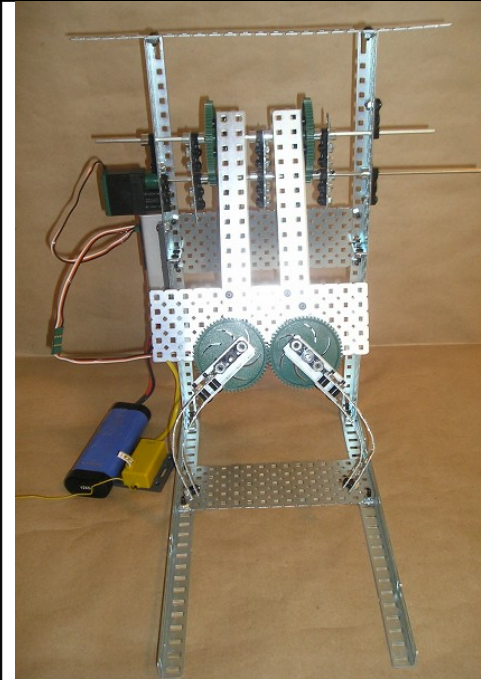

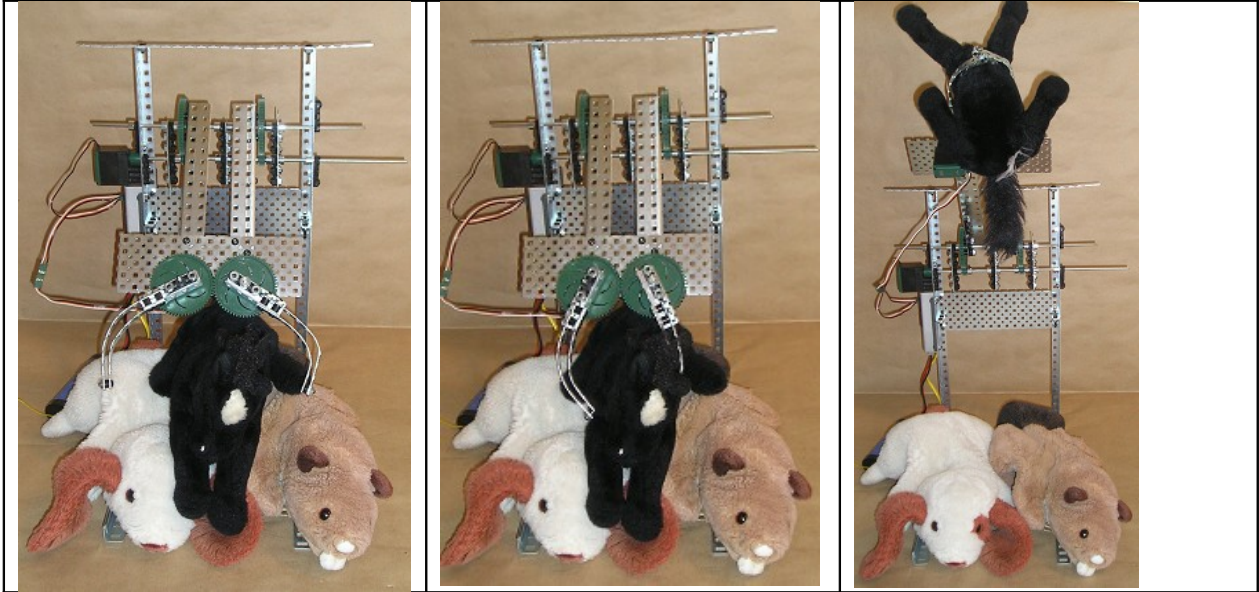

Project Notes and Engineering Principles

Lifts

One very important consideration in designing a lift is the amount of torque required, which depends on the weight lifted and the length of the arm. It is important to keep length of the lift arm to a minimum, as torque increases as you increase distance from the weight to the pivot point. Even so, most lifts (including this one) need to be geared down, trading speed for increased strength.

Bracing

Another consideration in this design is that the weighted long axle tends to bend downward, preventing the gears from fitting snugly together and causing them to slip. For this reason, 3 braces are inserted between axles, keeping the distance between the 2 axles constant. Had the 2 side supports been placed closer together, the axles would have less of a tendency to bend, making the braces unnecessary. However, this would produce a narrower base, and the structure would be more likely to tip over. It is often necessary to make tradeoffs like this.

Various long bars and plates are used to brace the frame. The size of these supports is flexible – pieces that hang over the edge are acceptable, even if they don't look pretty. This is a concession to minimize cutting, as too-large pieces can be reused in other projects that require larger pieces; once cut too small, they can't be increased in size.

Part 2: Beginning Programming Projects

The ability to make robots that move *autonomously* (i.e., without user input) is what distinguishes a true "robot" from a remote control vehicle. Without programming, the capability of your powerful (and expensive, compared to a remote controlled car) microprocessor goes to waste.

There are currently 3 programming options available. EasyC is icon-based and is fittingly the easiest to learn. Because its commands are drag-and-drop icons, users experience fewer syntax errors, as one cannot misplace stray semicolons and brackets. Its disadvantages include slow download times and certain limitations that experienced programmers find frustrating (novice programmers most likely won't know what they're missing). ROBOTC is text-based, but menu driven. Because commands are typed, not selected, it is more likely that syntax errors will occur. However, downloading of programs is faster, and the language is more flexible than EasyC. ROBOTC is also available for multiple hardware systems (including LEGO Mindstorms NXT), so learning is transferable if you switch to a compatible system. MPLAB is generally recommended only for experienced C users. More facts for comparison are available at: <http://www.vexrobotics.com/vex-robotics-programming-kit.shtml>.

Because this guide is designed for beginners, EasyC is used. It is recommended that you work through the tutorial that comes packaged with the CD in the programming kit. If you did not receive a tutorial, it can be downloaded here: <http://www.vexrobotics.com/docs/inventors-guide/programming-guide.pdf>

In addition to the programming kit, you may want to purchase additional sensors. The Kentucky Do-Nothing and the Edge Detector make use of sensors already included in the Starter Kit, the bumper switch and limit switch. The other sensors (line follower, ultrasonic range finder, optical shaft encoder, and light sensors) must be purchased separately. Soon-to-be released sensors include the potentiometer, compass sensor, accelerometer, and gyroscope.

The required mechanical parts in these projects have been deliberately kept to a minimum, using only parts in the Starter Kit. The Basicbot and Flexigearbot are selected as the driving bases for simple construction. In some cases, the bases are interchangeable. For others, the Basicbot is preferable for maneuverability, while in others, the Flexigearbot is preferred for its lower gear-ratio, producing a slower robot capable of more precise sensing. The programs are also simple (many with ideas borrowed from other robotic systems) and are designed to demonstrate the use of one sensor at a time.

For debugging, there are 2 useful diagnostic tools at your disposal: the Online Window and the Terminal Window (which displays the results of all "Print to Screen" commands. More details on use can be found in *Vex for the Technically Challenged*.

The Kentucky Do-Nothing

Project Description: Robot programmed to reverse direction whenever it bumps a wall or obstacle.

Kits needed:

- 1 Starter kit
- 1 Programming kit

Cut Pieces Needed: None

Bill of Materials

- 1 Basicbot chassis
- 2 bumper sensors
- 8 screws

Build Sequence:

Attach one bumper to the front and one to the back.

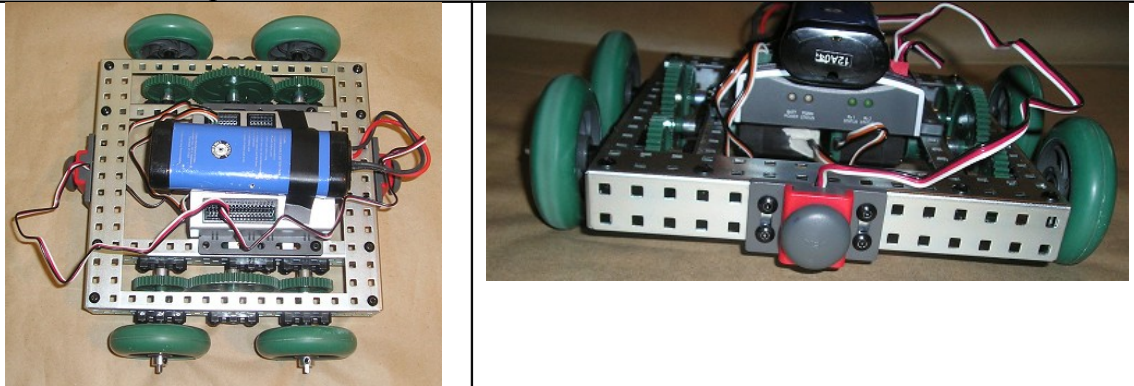

Plug in motor wires (left wire to motor port 2, right wire to port 3). Insert front sensor wire into digital input 5 and the back sensor wire into digital input 6 (located on the analog/digital strip).

Programming and Operation

Enter the program shown below. Although variables are not visible from the EasyC code, there are 2 variables that must be defined: bumper1 and bumper2. These 2 variables will hold the input from each of the bumper sensors, 1 or 0, and thus, the type "int" (integer) is most suitable. To define variables, click on the "variables" icon in the stack. For the first variable, under "Type", the drop-down menu will allow you to select the type, in this case, "int" for integer. In the next box, the name of the variable should be entered (bumper 1). No value is listed, since it will change value throughout the program. The true C code shows the definition of these 2 variables.

It is advisable to hold the robot with its wheels off the ground (a stack of paperbacks to prop up the center is effective) while downloading, as the robot will be off to the races as soon as downloading is complete.

Place the robot in a narrow corridor (away from furniture and breakables) with the bumpers facing opposite walls, and watch it bounce off the walls, reversing as it bumps.

If the robot does not reverse unless the "wrong" bumper is pressed, you may have to exchange the sensor wires in ports 5 and 6.

It is rare that 2 motors are perfectly matched, and if the walls are separated by too great a distance, the robot will tend to veer, as the difference in speeds on either side will cause the robot to travel in a curved or circular path. If there is enough space, it may even bounce off the same wall, traveling back and forth in a semicircle.

The motor speeds in this program are set at 0 and 255, the maximum clockwise and counterclockwise speeds. Choosing speeds closer to the "stop" position of 127, say 55 and 200 will cause the robot to travel more slowly. Any curving of the robot can also be straightened to some extent by tweaking the motor speeds accordingly.

```
void main ( void )
{
  while ( 1 == 1 )
  {
    SetMotor ( 2 , 255 );
    SetMotor ( 3 , 0 );
    bumper1 = GetDigitalInput ( 5 );
    while ( bumper1 == 1 )
    {
      bumper1 = GetDigitalInput ( 5 );
    }
    SetMotor ( 2 , 0 );
    SetMotor ( 3 , 255 );
    bumper2 = GetDigitalInput ( 6 );
    while ( bumper2 == 1 )
    {
      bumper2 = GetDigitalInput ( 6 );
    }
  }
}
```

```
1 #include "Main.h"
2
3 void main ( void )
4 {
5   int bumper1;
6   int bumper2;
7
8   while ( 1 == 1 )
9   {
10    SetMotor ( 2 , 255 );
11    SetMotor ( 3 , 0 );
12    bumper1 = GetDigitalInput ( 5 );
13    while ( bumper1 == 1 )
14    {
15      bumper1 = GetDigitalInput ( 5 );
16    }
17    SetMotor ( 2 , 0 );
18    SetMotor ( 3 , 255 );
19    bumper2 = GetDigitalInput ( 6 );
20    while ( bumper2 == 1 )
21    {
22      bumper2 = GetDigitalInput ( 6 );
23    }
24  }
25 }
```

Project Notes and Engineering Principles

This beginning programming project requires minimal building skills. It does, however, introduce the concept of using sensors to govern motion. The outer "while" loop causes the robot to bounce off the walls indefinitely, until the robot is turned off.

The inner "while" loops serve as sensor watchers – the program keeps the motors running in the same direction and keeps looking at the bumper sensor until a change in value is detected.

The bumper sensor is a digital sensor, with possible readings of 1 (not pressed) or 0 (pressed). The default designation of analog/digital inputs and outputs is:

Ports 1 – 4: Analog inputs

Ports 5 – 10: Digital inputs

Ports 11 – 16: Digital outputs

The ports can be reconfigured if desired by double clicking on the "Config" button at the beginning of a program and using the right and left mouse buttons to change the input/output type of each port. Reconfiguring the 4 analog ports into digital ones would allow you to use ports 1 – 4 as digital inputs for this project.

The Scaredybot

Project Description: Robot programmed to back up whenever an "intruder" approaches it within 10 inches or less.

Kits needed:

- 1 Starter Kit
- 1 Programming Kit
- 1 Ultrasonic Sensor

Cut pieces needed: none

Bill of Materials:

- 1 Basicbot chassis
- 1 ultrasonic sensor
- 2 medium screws
- 2 keps nuts

Build Sequence:

Attach ultrasonic sensor to front of Basicbot chassis.

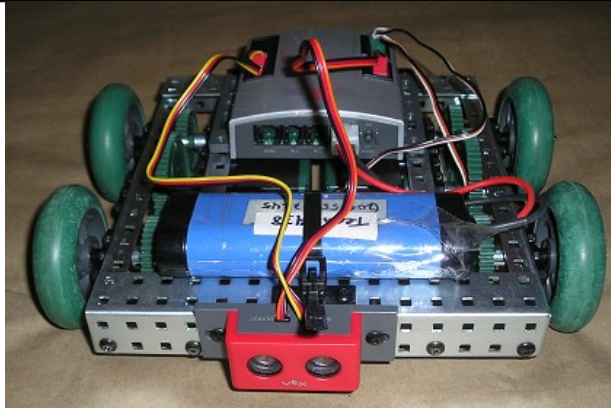

Plug left and right motor wires into motor ports 2 and 3. Plug the "Input" wire from the ultrasonic sensor into analog/digital port # 11 (this is a digital output). Plug the "Output" wire into interrupt port # 1.

Programming and Operation:

Download the following program. The variable "variablename" should be defined as an integer; it records the distance of the nearest obstacle, as detected by the ultrasonic sensor. The Scaredybot is antisocial – leave it alone and it sits placidly in place; walk into its "personal space" within a few inches of the ultrasonic sensor, and it backs away from you.

If an obstacle of is detected 10 inches away or nearer, the robot is programmed to back up for 1 second, and the cycle of waiting for the next "intruder" continues.

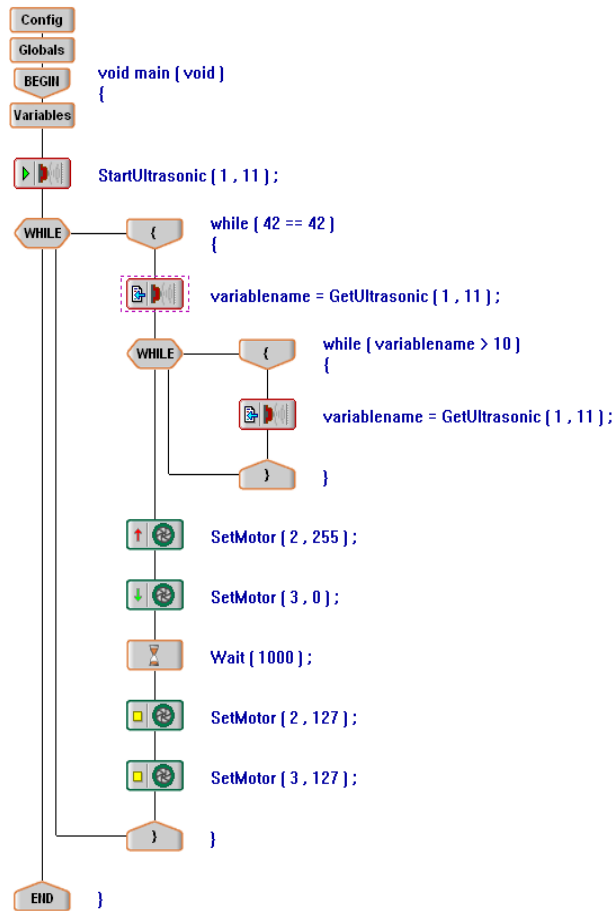

```

1 #include "Main.h"
2
3 void main [ void ]
4 {
5   int variablename;
6
7   StartUltrasonic [ 1 , 11 ];
8   while [ 42 == 42 ]
9   {
10    variablename = GetUltrasonic [ 1 , 11 ];
11    while [ variablename > 10 ]
12    {
13      variablename = GetUltrasonic [ 1 , 11 ];
14    }
15    SetMotor [ 2 , 255 ];
16    SetMotor [ 3 , 0 ];
17    Wait [ 1000 ];
18    SetMotor [ 2 , 127 ];
19    SetMotor [ 3 , 127 ];
20  }
21 }

```

Project Notes and Engineering Principles

When triggered, an ultrasonic sensor emits a high frequency ultrasonic signal which bounces off the nearest obstacle, returning to the sensor. As soon as the signal is sent, a timing loop on the microcontroller begins, which ends when the return signal is received. The time interval between signal sent and received determines the distance between the sensor and the nearest obstacle. A digital output from port 11 is used to trigger the start of the signal. The input is received through interrupt 1, and the variable receives and stores this number as the approximate distance in inches, calculated using the time interval.

The range of readings for the ultrasonic sensor is between 1 and 99 inches; accurate readings for distances as close as 3 inches can generally be obtained. Distances farther than 30 inches may be irregular and inconsistent – interfering factors which may produce unpredictable results include robot movement and the tilt of the sensors (toward or away from the floor).

Edge Detector

Project Description: Robot programmed to move away from the edge of a table, preventing it from falling off. It will also keep itself in the center of a room, moving away from walls.

Kits needed:

- 1 Starter kit
- 1 Programming kit

Cut Pieces Needed: None

Bill of Materials:

1 Basicbot chassis, preassembled	4 bearing blocks
2 limit sensors	12 keps nuts
4 threaded beams, 3"	2 large spacers
20 medium screws	2 collars
2 extra chassis bumpers (angle bars 7.5" or longer are OK if you only have the Starter Kit)	1 square bar (axle), 12"
2 bearing flats	2 plates, 3 X 3 holes or larger (4 X 5 plates are used here)
	2 long bars, 25 holes

Build Sequence:

Attach 2 vertical supports to Basicbot chassis (bumpers or angle bars)

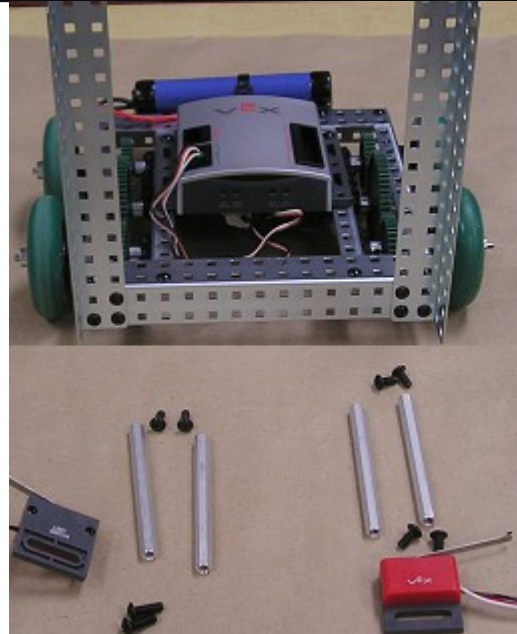
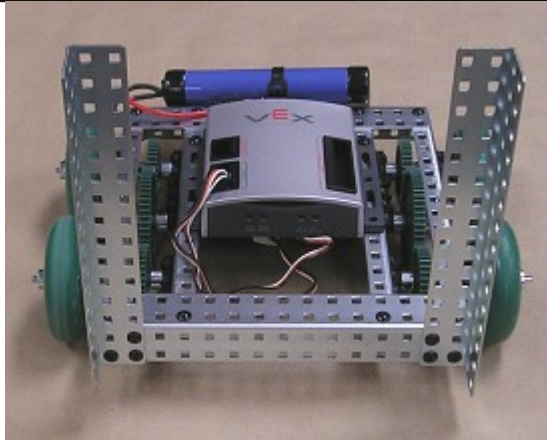

Attach light sensors to vertical supports with threaded beams.

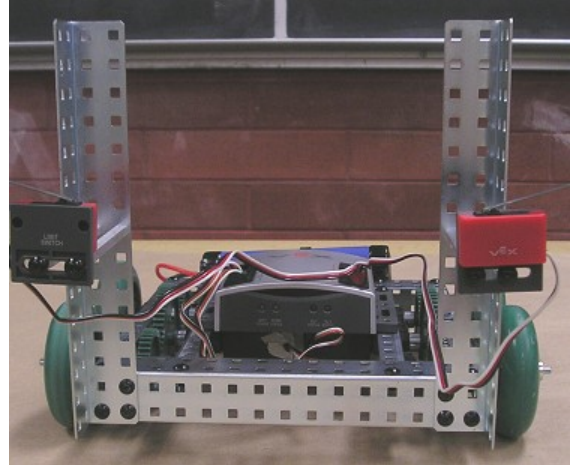
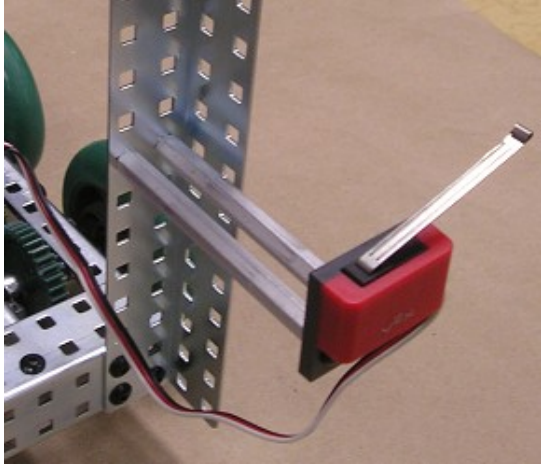

Attach bearing blocks to the sides of the vertical supports, leaving the bottom hole empty.

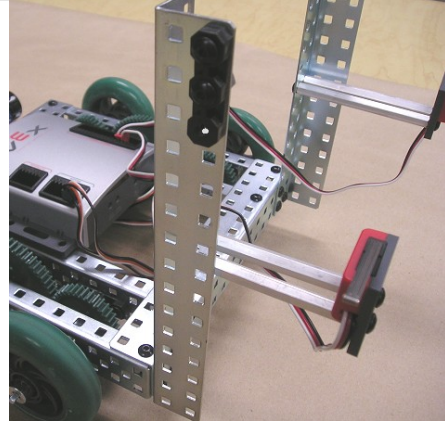
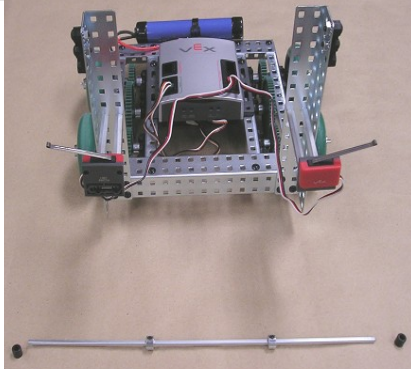

Insert axle through the bottom holes, anchoring with collars on the inside, spacers on the outside.

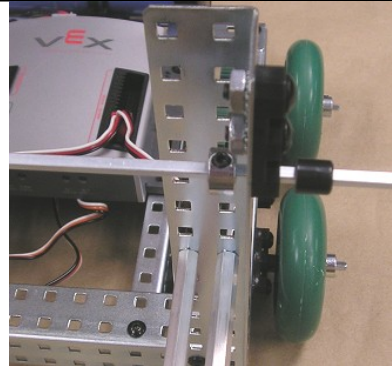
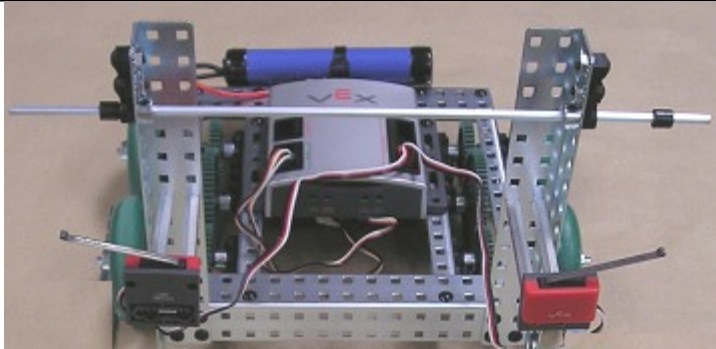

Assemble "arms" as shown.

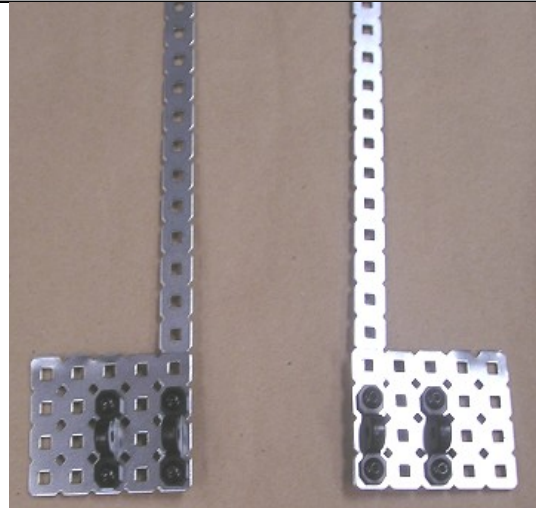
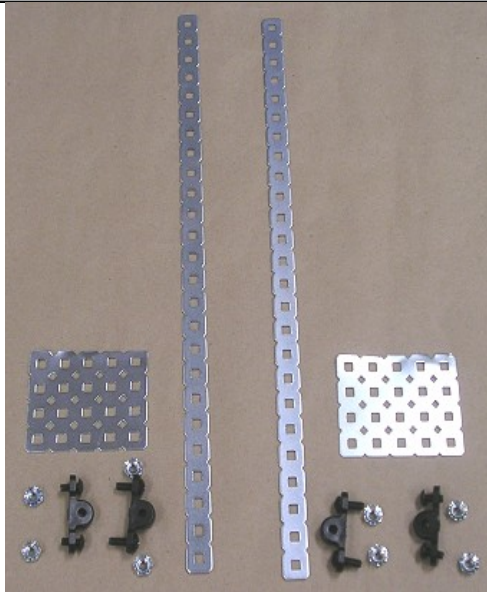

Slide bearing blocks onto axle ends. The "arms" can be flipped forward or backward and should not bump against the bearing flats mounted on the vertical supports – use more spacers if needed. Anchor with a collar.

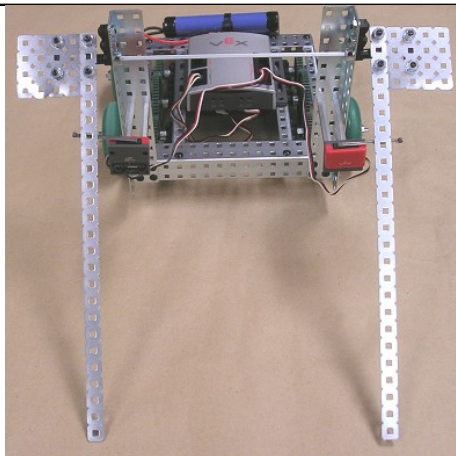
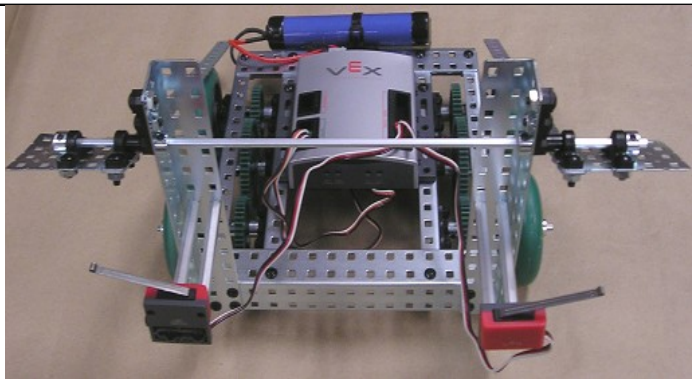

Bend the "arms" around the limit switches so that they almost touch the switch when resting on the ground. When an arm reaches the edge of the table, its weight should depress the switch. The switch should also be pressed when the arm bumps into a wall or barrier. Plug the motor wires into motor ports 2 (right) and 3 (left), the sensor wires into digital inputs 5 (right) and 6 (left).

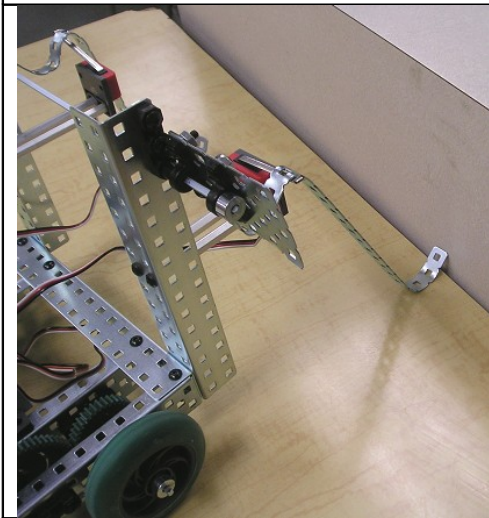
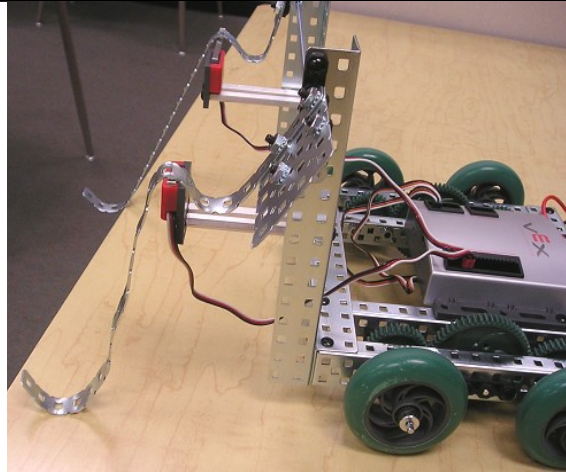
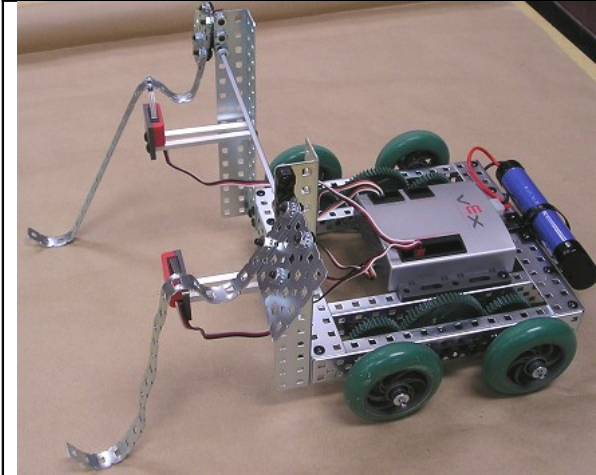

Programming and Operation

Enter and download the following program, which looks at both the left and right sensors from digital inputs 5 and 6. Define the variables "left", "right", and "sum" under "Variables" as integers. To operate, place the robot on a tabletop with both arms supported by the table. Note that when the robot reaches an edge, one of the arms is unsupported, triggering the limit switch. The robot backs up and swings in the opposite direction of the arm that fell off (it attempts to get closer to the center of the table). The robot also can be used to detect walls.

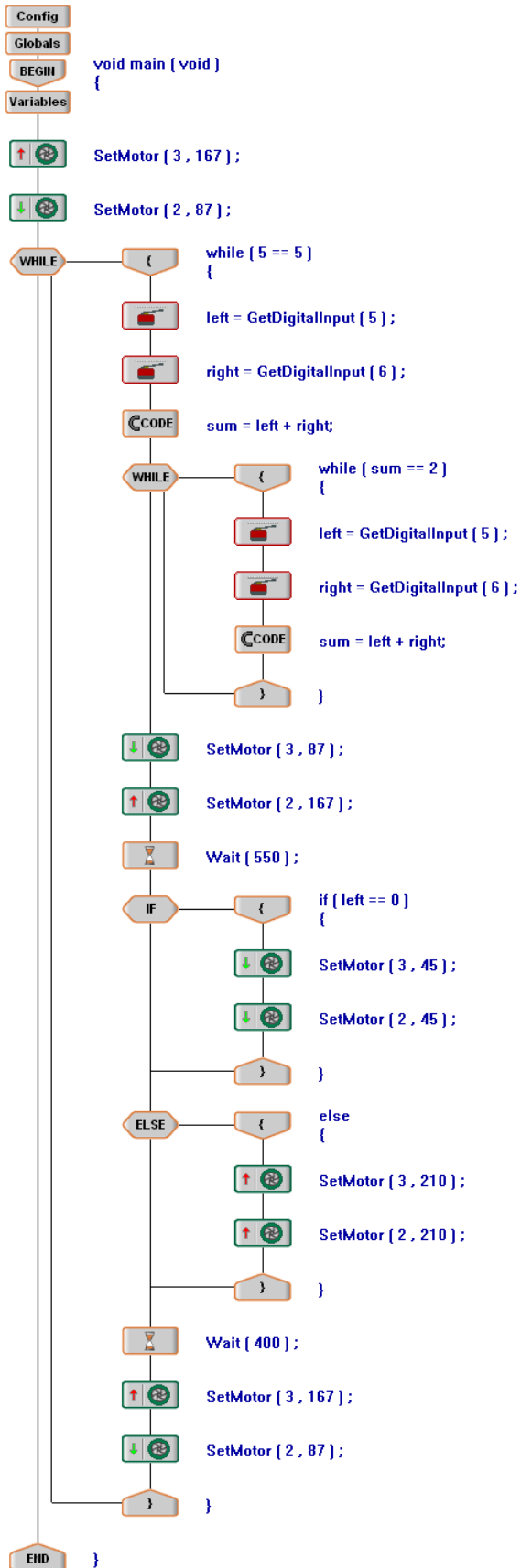

```

1 #include "Main.h"
2
3 void main ( void )
4 {
5     int left = 1;
6     int right = 1;
7     int sum = 2;
8
9     SetMotor ( 3 , 167 );
10    SetMotor ( 2 , 87 );
11    while ( 5 == 5 )
12    {
13        left = GetDigitalInput ( 5 );
14        right = GetDigitalInput ( 6 );
15        sum = left + right;
16        while ( sum == 2 )
17        {
18            left = GetDigitalInput ( 5 );
19            right = GetDigitalInput ( 6 );
20            sum = left + right;
21        }
22        SetMotor ( 3 , 87 );
23        SetMotor ( 2 , 167 );
24        Wait ( 550 );
25        if ( left == 0 )
26        {
27            SetMotor ( 3 , 45 );
28            SetMotor ( 2 , 45 );
29        }
30        else
31        {
32            SetMotor ( 3 , 210 );
33            SetMotor ( 2 , 210 );
34        }
35        Wait ( 400 );
36        SetMotor ( 3 , 167 );
37        SetMotor ( 2 , 87 );
38    }
39 }

```

Project Notes and Engineering Principles

The limit sensor, like the bumper sensor, is a digital sensor, with possible readings of 1 (not pressed) or 0 (pressed). The sensor loop continues while neither limit sensor is pressed (sum of 2 sensor readings = 2). When either sensor is pressed, the robot backs up and turns (direction depending on which sensor detects the edge), then repeats by going forward toward the edge again.

Line Follower

Project Description: Robot programmed to follow a black line using a single line follower sensor.

Kits needed:

- 1 Starter Kit
- 1 Programming Kit
- 1 Line Tracker kit

Cut Pieces Needed:

- 1 long bar, 9 holes

Bill of Materials:

1 Flexigearbot, preassembled (using 1:1 gearing w/ 4 medium gears)	1 gusset plate
1 Line Tracker sensor	5 medium screws (3/8" or 1/2")
1 long bar (9 holes)	5 keps nuts

Build Sequence:

Assemble the flexigearbot. Attach a 9-hole strip to the front.

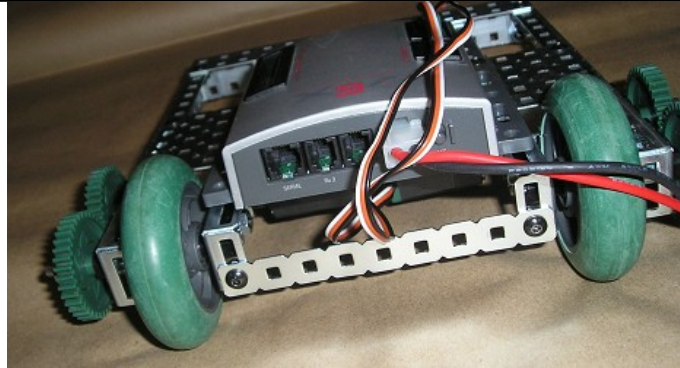
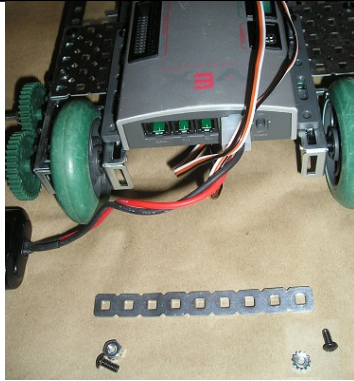

Attach the line tracker sensor to the front using a gusset plate (bottom views)

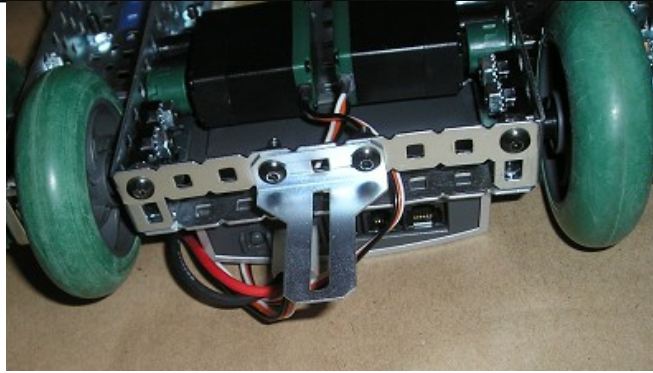
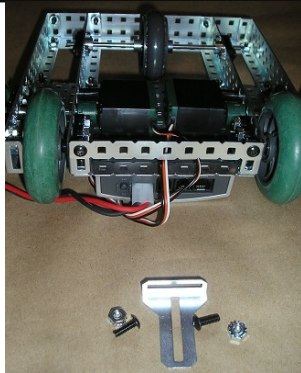

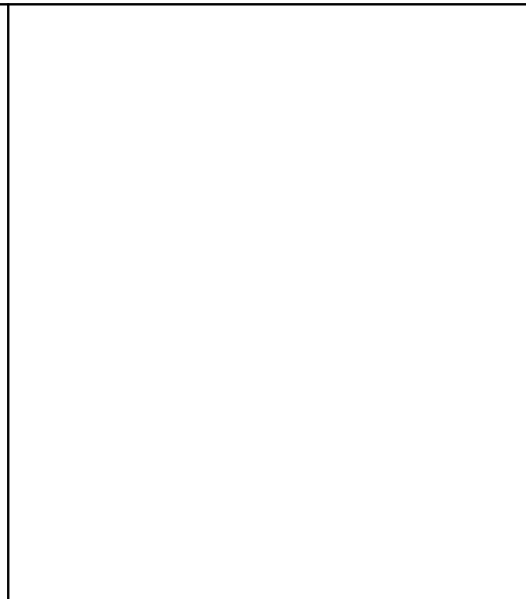
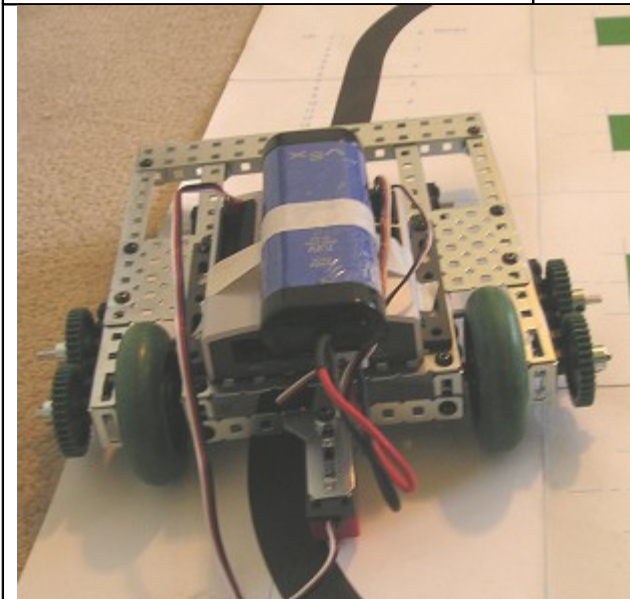
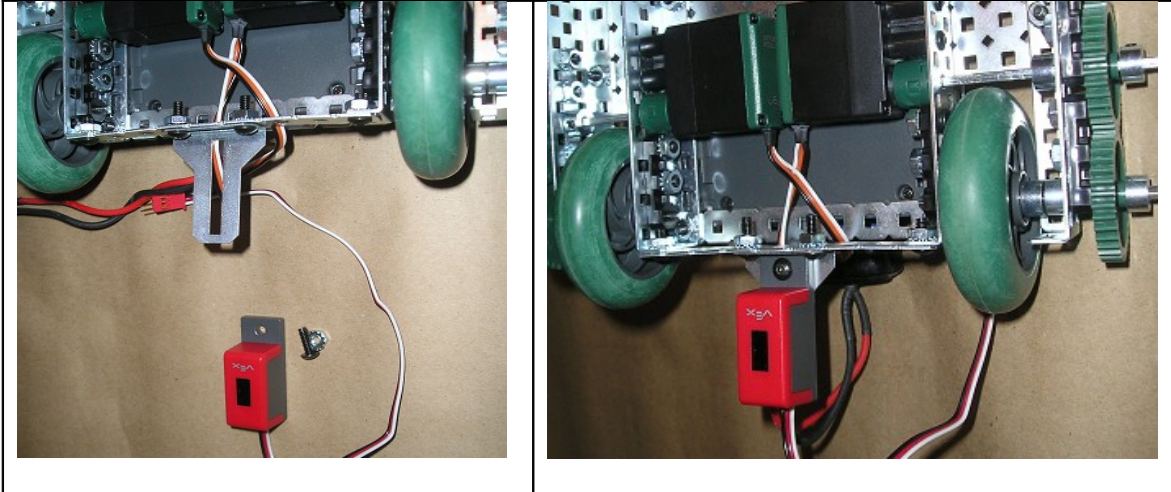

Plug left and right motor wires into ports 2 and 3. Plug the line follower sensor into analog input 1.

Programming and Operation

The variable "light" should be defined as an integer under "Variables." Then enter and download the program shown below.

A threshold of 650 was chosen to separate "light" from "dark", as the lighting conditions in the room varied between 30 and 600 for "white" and >700 for "black." Depending on the lighting in your room, this value may need to be adjusted. Motor speeds of 64 and 192 were chosen so that the robot travels slowly enough for the sensor to detect the line before driving completely over it.

The robot should be placed on the left side of the line (as it faces forward).

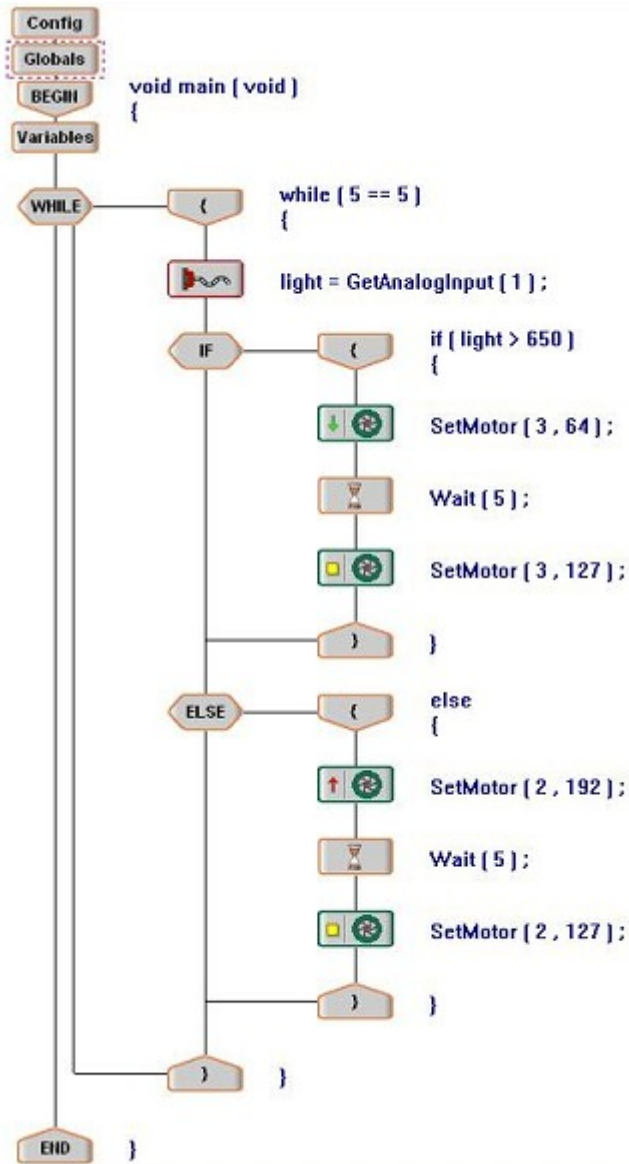

```

1 #include "Main.h"
2
3 void main ( void )
4 {
5   while ( 5 == 5 )
6   {
7     light = GetAnalogInput ( 1 );
8     if ( light > 650 )
9     {
10      SetMotor ( 3 , 64 );
11      Wait ( 5 );
12      SetMotor ( 3 , 127 );
13    }
14    else
15    {
16      SetMotor ( 2 , 192 );
17      Wait ( 5 );
18      SetMotor ( 2 , 127 );
19    }
20  }
21 }

```

Project Notes and Engineering Principles:

The line tracker sensors give readings between 0 and 1023, with 0 being brightest, and 1023 being darkest. The readings vary greatly depending on the lighting conditions in the room and the distance from the sensor to the surface being read. More accurate readings with less variation occur when the sensor is as close to the marked surface as possible.

This line follower follows the edge between black and white on the left side of a line. It starts on the left and first "looks for" the line on its right. When sensor readings cross the threshold from light to dark, the robot turns away from the line briefly, then turns toward it again, until it finds it. It continues to follow the edge between white and black, as long as the black is on the right and the white is on the left.

If the line is too thin or the corners are too sharp, the robot will drive over the line without detecting it. Driving more slowly is one way to solve this problem; for this reason the 1:1 configuration of the Flexigearbot was chosen (rather than a geared-up bot

like the Basicbot). In addition, the motors were programmed to run at speeds of less than full capacity.

Further Challenges

Can you devise a line follower that uses 2 sensors that straddle a black line? What advantages and disadvantages are there to this arrangement? How about a 3-sensor line follower?

Boomerang

Project Description: Using remote control, the user moves a robot a desired distance, and programming returns it to its original position.

Kits needed:

- 1 Starter kit
- 1 Programming kit
- 1 Optical Shaft Encoder Kit (Quadrature Encoder Kit may be used, but will require reprogramming)

Cut Pieces Needed:

- 1 square bar (axle), 4"
- 1 angle bar, 5"

Bill of Materials:

1 Basicbot or Flexigearbot, (using 1:1 gearing w/ 4 medium gears)	1 angle bar, 5"
1 optical shaft encoder (or quadrature encoder)	1 threaded beam, 1/2 "
1 square bar, 4"	2 short screws, 1/4 "
	5 medium screws, 3/8" or 1/2"

Build Sequence:

Replace the 3" axle on the right motor with a 4" axle. Mount the encoder on the axle. If using a Basicbot, use replace one axle with a 4" axle and mount the encoder on the outside of the wheel.

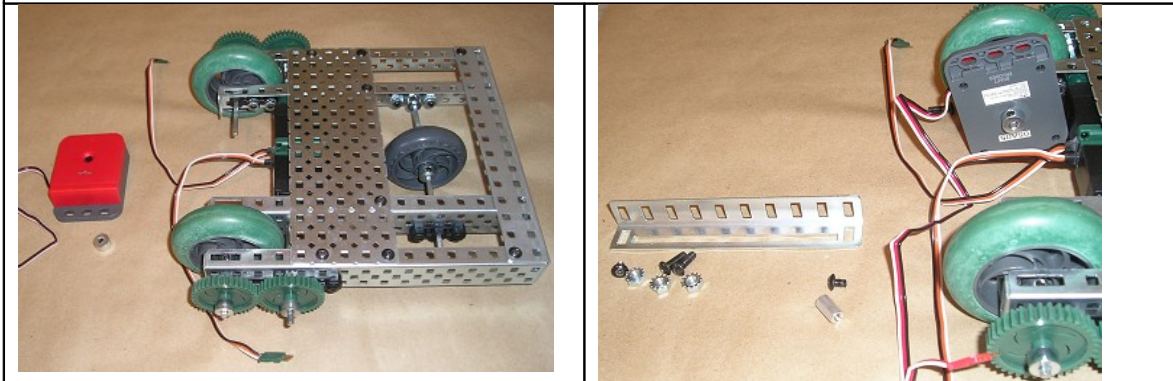

Attach the encoder to the 5" angle bar. Stabilize the bar with ½" threaded beam, attaching the beam at both ends with short screws.

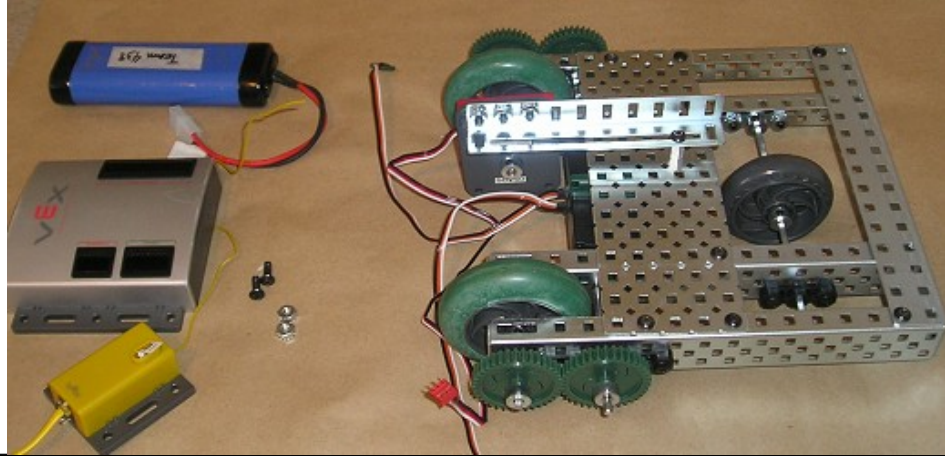

Attach the microcontroller, RF module and battery, attempting to evenly distribute the weight. Plug motors into motor ports 2 and 3. Plug the encoder wire into interrupt port 2.

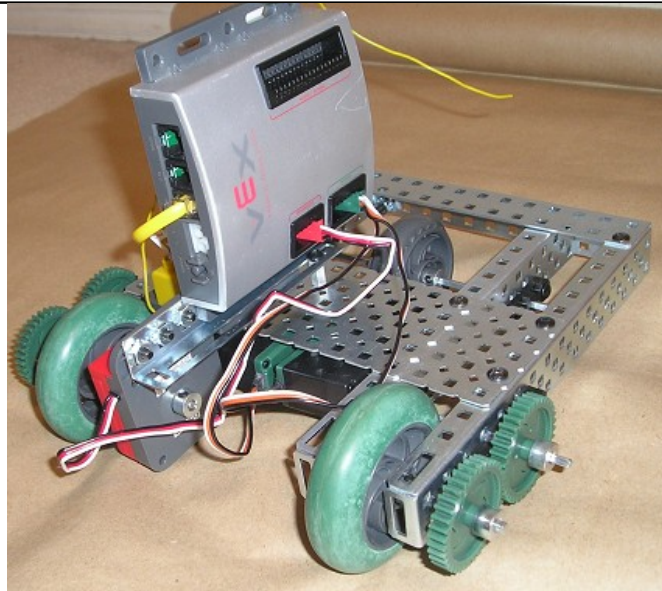

Programming and Operation:

Enter and download the program shown below, defining variables "encoder", "stick", and "dist" as integers. Use the Channel 2 (the left joystick) to move the robot forward a desired distance. When you release the joystick, the robot should return (more or less) to its original position. There may be some discrepancy in position due to slippage.

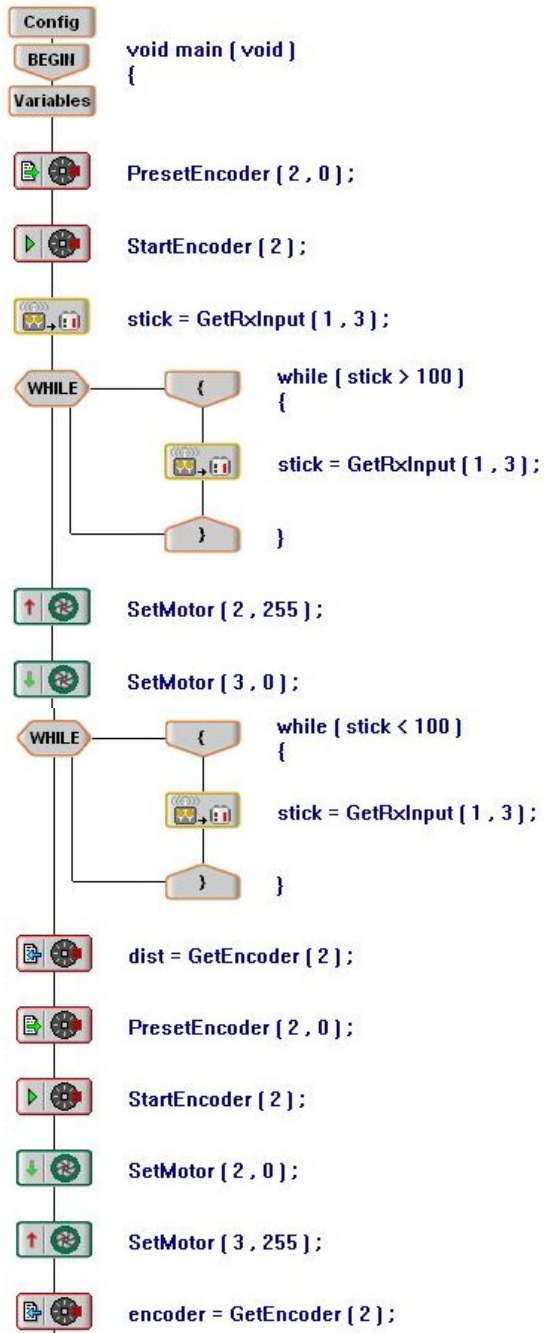

```

1 #include "Main.h"
2
3 void main ( void )
4 {
5     int encoder = 0;
6     int stick = 127;
7     int dist = 0;
8
9     PresetEncoder ( 2 , 0 );
10    StartEncoder ( 2 );
11    stick = GetRxInput ( 1 , 3 );
12    while ( stick > 100 )
13    {
14        stick = GetRxInput ( 1 , 3 );
15    }
16    SetMotor ( 2 , 255 );
17    SetMotor ( 3 , 0 );
18    while ( stick < 100 )
19    {
20        stick = GetRxInput ( 1 , 3 );
21    }
22    dist = GetEncoder ( 2 );
23    PresetEncoder ( 2 , 0 );
24    StartEncoder ( 2 );
25    SetMotor ( 2 , 0 );
26    SetMotor ( 3 , 255 );
27    encoder = GetEncoder ( 2 );
28    while ( encoder < dist )
29    {
30        encoder = GetEncoder ( 2 );
31    }
32    SetMotor ( 2 , 127 );
33    SetMotor ( 3 , 127 );
34 }

```

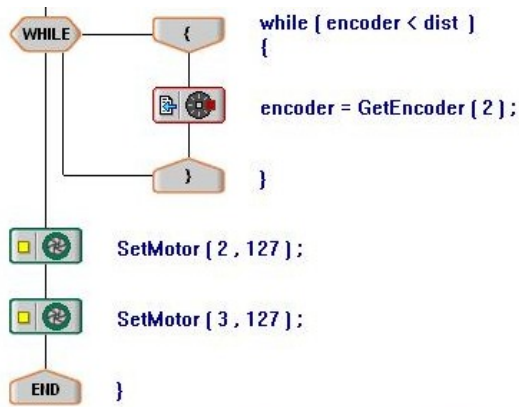

Project Notes and Engineering Principles:

The optical shaft encoder flashes light through a series of cutouts to a light detector. As the shaft rotates, the flashes are counted, with 90 counts equal to one full rotation of the shaft. Unfortunately, the encoder cannot determine whether the rotations are clockwise, counterclockwise, or a mixture, so the count must be stored in a variable every time the direction of motion changes.

This program waits for Channel 2 (the left joystick) to move the robot forward, then measures the distance it travels until the joystick is released and stores it in the variable "dist". It then resets and reverses direction until the encoder rotation equals "dist", returning the robot to its original position.

The program also demonstrates the ability to read input from an R/C channel, as if it were a sensor.

Further Challenge:

The program, as written requires that you turn the microcontroller off and on every time you want to relaunch of the "boomerang". Can you modify the program so that the robot can be launched and returned until you get tired of playing with it?

Light Seeker

Project Description: Robot programmed to follow a stationary or slow-moving light source.

Kits needed:

- 1 Starter Kit
- 1 Programming Kit
- 1 Light Sensor

Cut Pieces Needed: none

Bill of Materials:

1 Basicbot chassis	1 motor module
1 light sensor	1 bearing flat
1 lock plate	2 motor screws
1 gusset	1 square bar (axle), 2"
11 medium screws	1 small spacer
3 keps nuts	4 threaded beams
1 plate, 5 X 15 holes	

Build Sequence:

Attach lock plate to bottom of gusset, leaving center (square) hole open. Attach light sensor to side of gusset.



Attach motor and bearing flat to plate; insert axle.

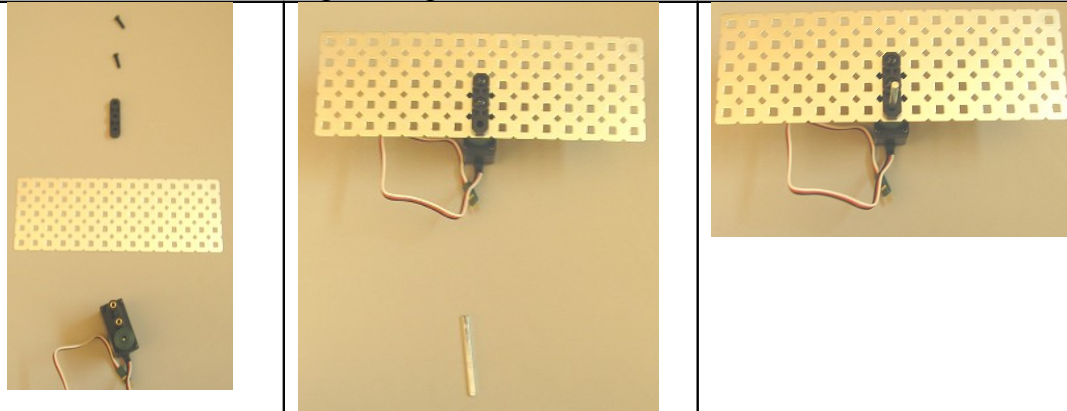

Add small spacer to axle, then insert axle through lock plate attached to gusset.

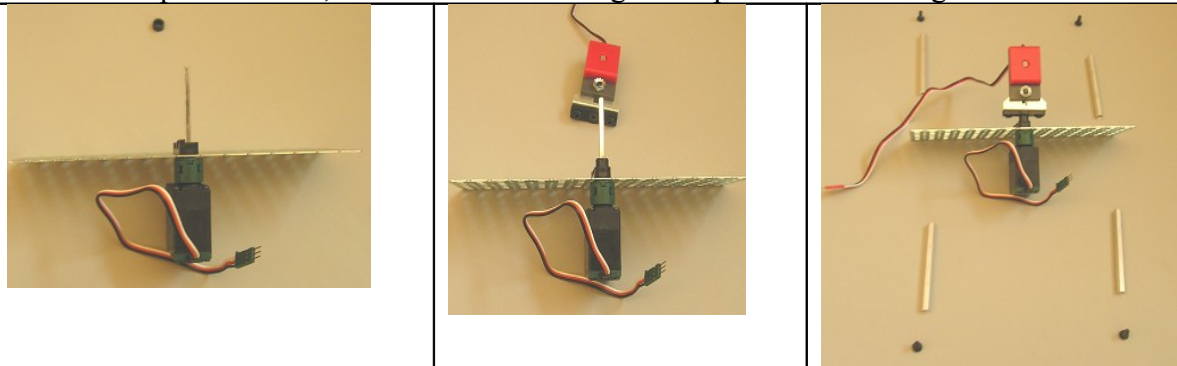

Attach threaded beams to 4 corners of plate, and mount on Basicbot chassis.

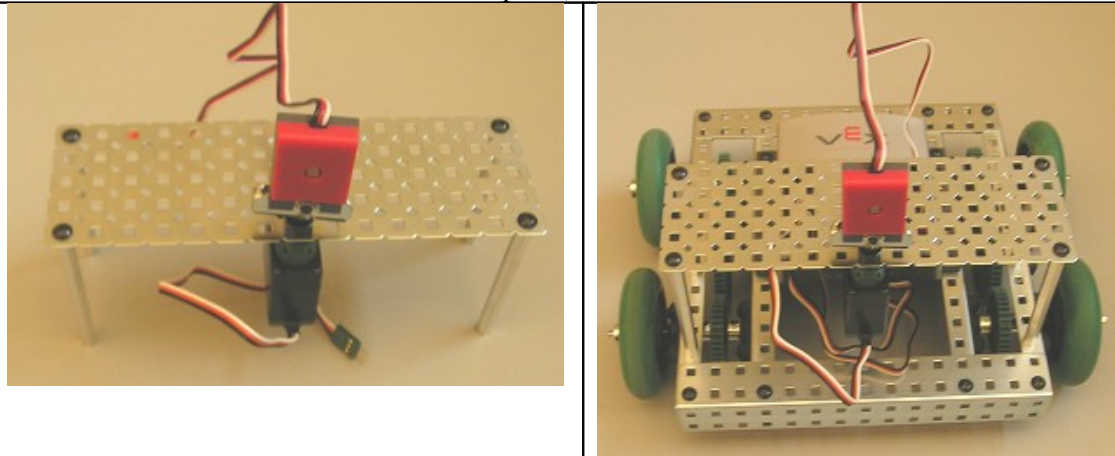

Programming and Operation:

Download the following program, defining the variables "leftlight" and "rightlight" as integers. This light seeker samples light readings from 2 positions (left and right) and uses the relative light readings to go in the direction of the lightest (brightest) reading. It functions best when there is a single source of light in an unambiguous, stationary location (for example, a dark garage with a single window). It can also follow a flashlight if the light moves slowly enough, as the sample time for the 2 readings is slow – "wait" commands were required in order for the sensor to obtain stable readings.

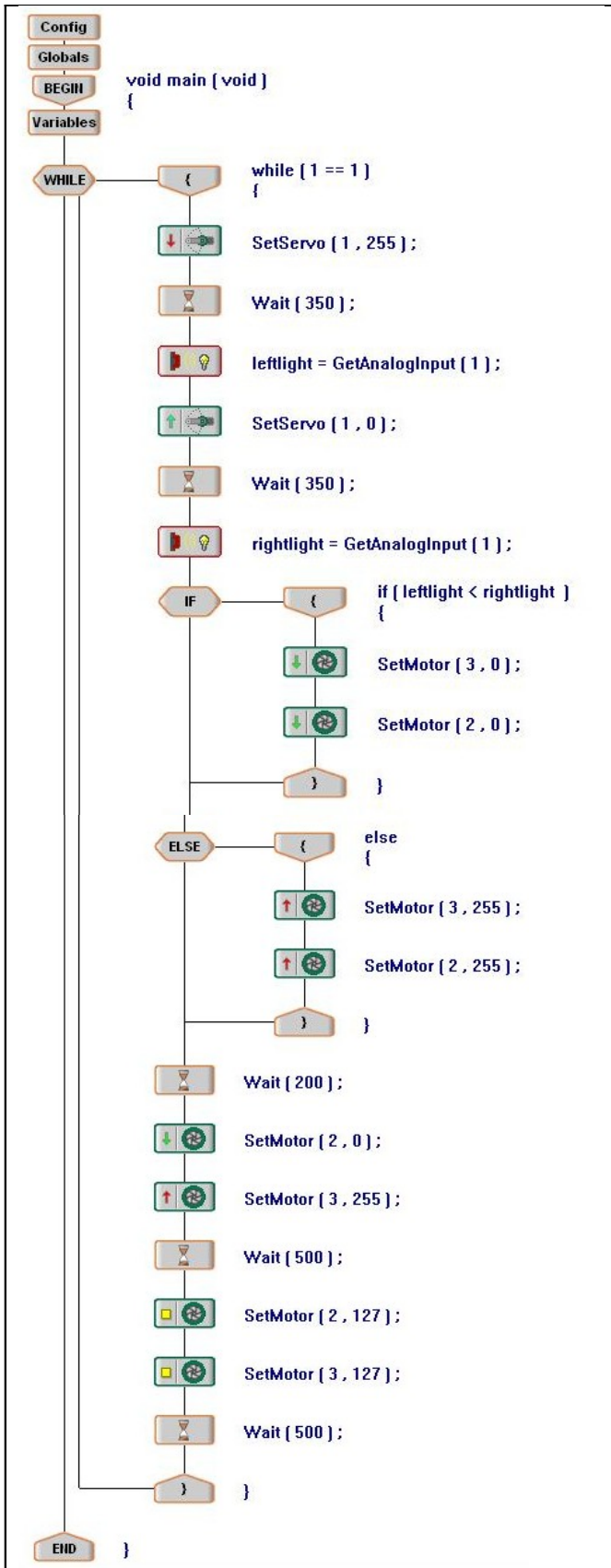

```

1 #include "Main.h"
2
3 void main ( void )
4 {
5   int leftlight;
6   int rightlight;
7
8   while ( 1 == 1 )
9   {
10    SetServo ( 1 , 255 );
11    Wait ( 350 );
12    leftlight = GetAnalogInput ( 1 );
13    SetServo ( 1 , 0 );
14    Wait ( 350 );
15    rightlight = GetAnalogInput ( 1 );
16    if ( leftlight < rightlight )
17    {
18      SetMotor ( 3 , 0 );
19      SetMotor ( 2 , 0 );
20    }
21    else
22    {
23      SetMotor ( 3 , 255 );
24      SetMotor ( 2 , 255 );
25    }
26    Wait ( 200 );
27    SetMotor ( 2 , 0 );
28    SetMotor ( 3 , 255 );
29    Wait ( 500 );
30    SetMotor ( 2 , 127 );
31    SetMotor ( 3 , 127 );
32    Wait ( 500 );
33  }
34 }
  
```

Optional program improvements

The program above can be improved upon in many ways. Probably the most obvious of these is timing. The robot always spins for 0.2 seconds before moving forward, and always moves forward for 0.5 seconds. These values can be tweaked to enhance precision; ideally the robot's "spin" should leave it facing exactly the same direction that its eye was facing, rather than in approximately the correct direction.

Notice that the program follows the same loop: the mounted eye always looks left, then right. This means that the beginning of each loop, the eye must move from looking right to looking left before moving from looking left to looking right. What if the eye had two cycles that it alternated between: looking left before looking right, and looking right before looking left?

Also consider that the program commands the robot to stop moving while it scans the environment for light sensor readings. Could the efficiency be improved if the robot continued moving forward while sampling the light? What if the robot simply reduced its speed instead of stopping?

Project Notes and Engineering Principles:

The light sensor and the line follower sensor are both light sensors, but there are slight differences in structure and function. The line follower sensors emit light, which is reflected off a light or dark surface and detected by the sensor. Readings are best obtained when the sensor is very close to the surface reflecting the emitted light. In contrast, the light sensor does not emit or depend on reflected light. Instead, it uses a photocell, whose resistance varies with the amount of light, and the source of light or reflecting surface does not necessarily need to be close. The variable resistance readings are analog values, with the lowest values (near 0) indicating brightness and higher values (near 1023) indicating darkness.

This light seeker compares the light values to the left and right, and drives an incremental distance toward the direction which gives the lower (brighter) value.

Part 3: Advanced Mechanical Projects

Cool kits with advanced mechanical parts are available, but without knowing how to use them properly, they too, can become expensive closet hogs. We wanted to include projects that give a taste of what can be done with a few nifty doodads. These include advanced gears (differential, bevel gears, and rack gears), chain & sprockets, tank treads, and omniwheels. Use of the servo motor is also introduced here, as well as more complicated gearing assemblies.

As you become a better builder, you will hopefully become more comfortable with taking short cuts, making substitutions, and constructing subassemblies in a different order than they may be presented here, as well as making design modifications and improvements. There are always better ways to do things, and it's up to you to find them.

Tricycle Drive



Project Description: Alternative drive, using one control for forward/reverse movement, and one control for steering.

Kits Needed: 1 Vex Starter Kit
 1 Advanced Gear Kit
 1 Chain and Sprocket Kit





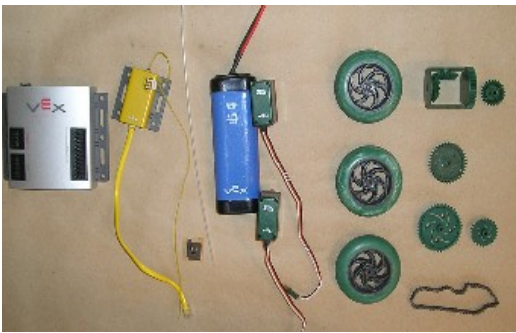

Cut Pieces Needed

2 square bars, 6"
 1 square bar, 4"
 2 angle bars, 2 ½"
 1 angle bar, 5"

Bill of Materials:

<p>1 microcontroller 1 RF receiver module 1 antenna sleeve holder 1 antenna sleeve 1 battery pack 1 motor module 1 servo module 3 small wheels 1 differential 3 bevel gears 1 medium (36-tooth) gear 1 large sprocket 1 medium sprocket ~ 9" sprocket chain 4 chassis rails 2 chassis bumpers 1 metal plate (5" X 15") 1 angle bar (5") 2 angle bars (2 ½ ")</p>	<p>2 square bars (6") 1 square bar (4") 2 square bars (3") 1 square bar (2") 4 threaded beams (2") 37 keps nuts 13 collars 2 large spacers 2 small spacers 3 lock bars 11 bearing flats 3 long motor screws 1 short motor screw 5 screws (¼ ") 6 screws (3/8") 30 screws (½ ") – substitute 3/8" if short 2 screws (3/4") 2 screws (1")</p>
	

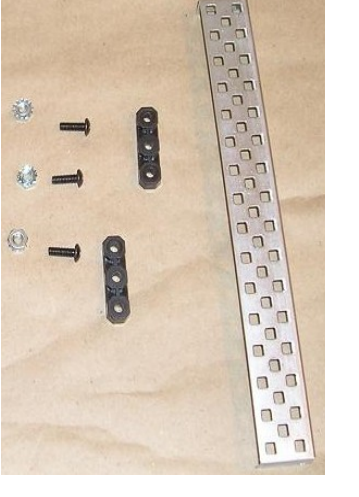
Build Sequence:

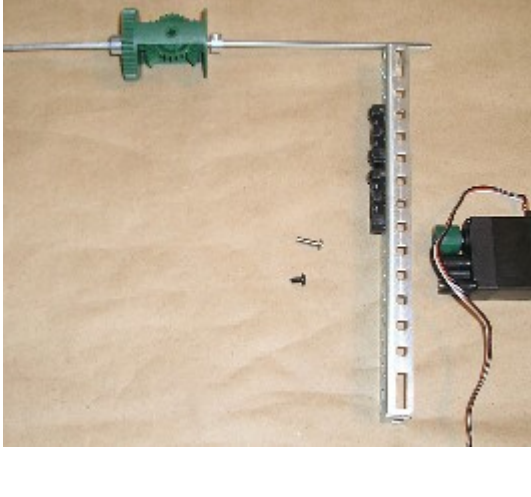
<p>Snap 2 bevel gears into differential</p>	<p>Insert 6" axles into differential, inserting bevel gear, anchoring with collars.</p>	
		
		
		
<p>Attach bearing flats to chassis rails.</p>		
		

Attach motor module to chassis rail. Insert axle and attach gear.

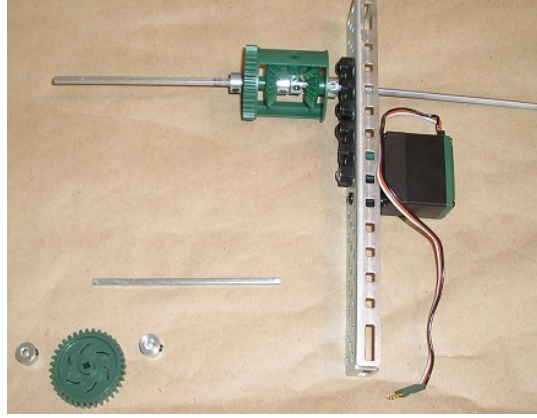
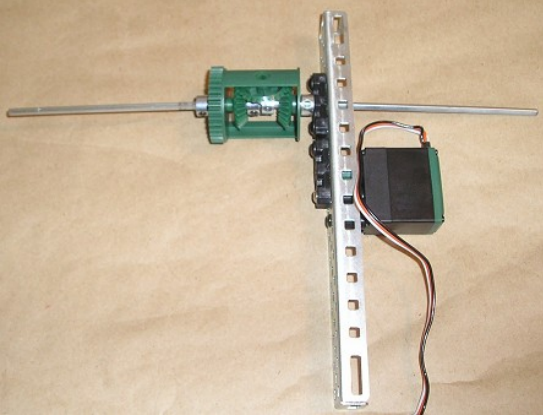

Prepare chassis rail for left side of gears.

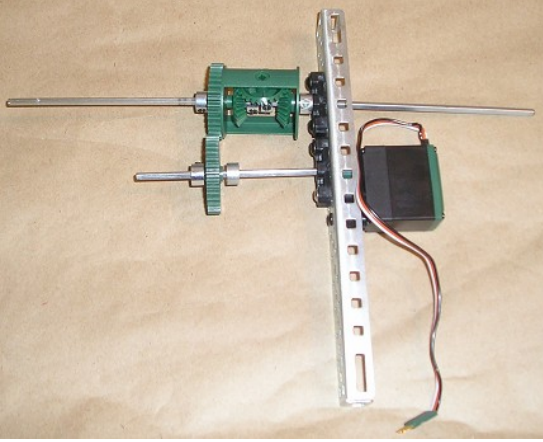

Add bearing flats to 2 additional chassis rails for outsides of bot.

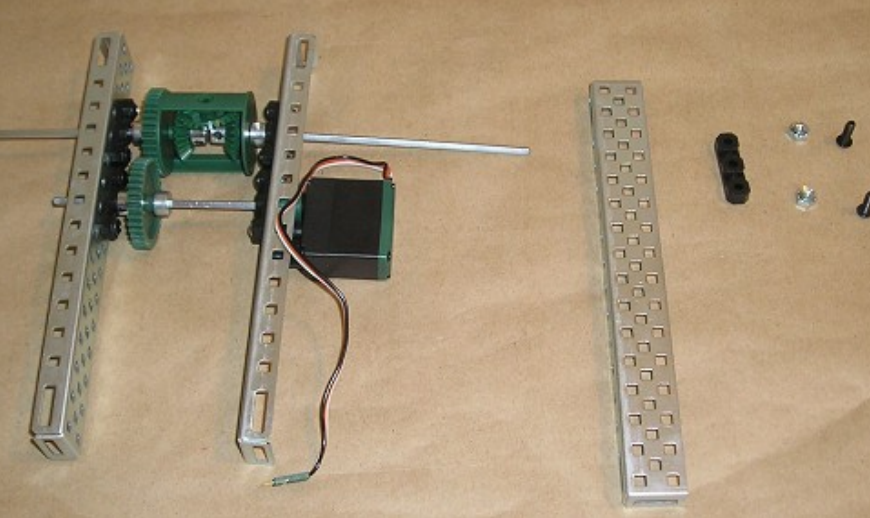

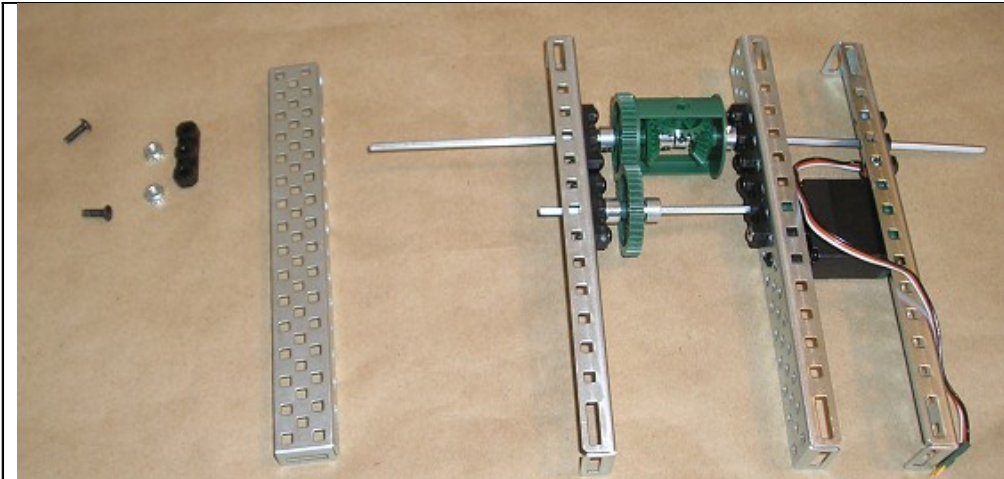

Add a large spacer to axles, add wheels, and anchor with collars on both sides.

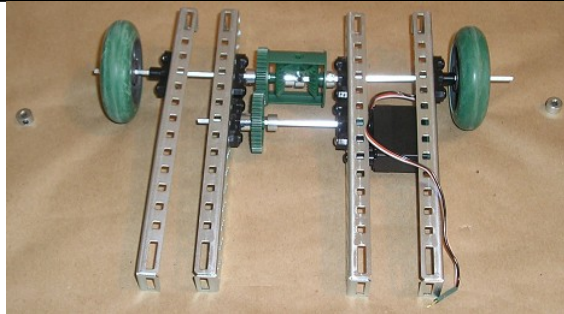
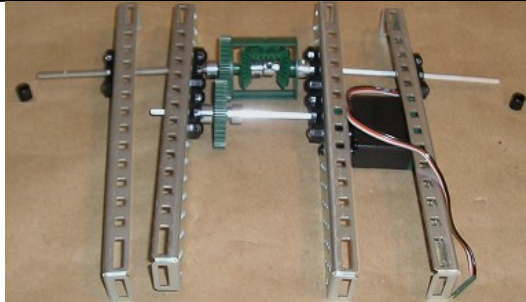

Attach chassis bumpers to the front and back.

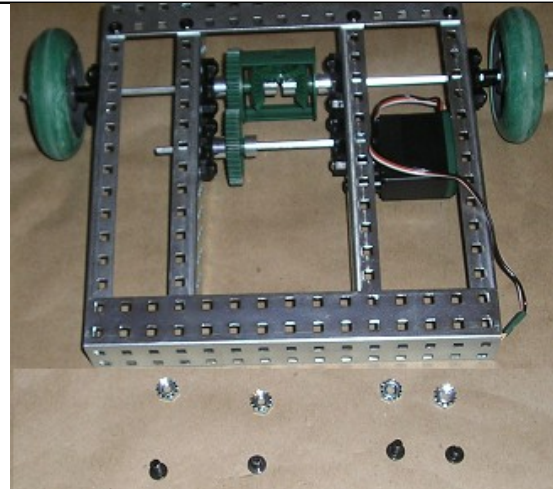
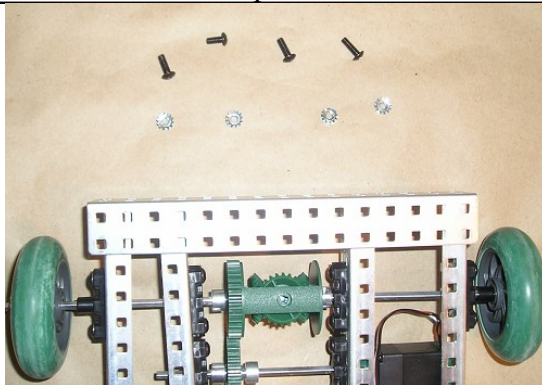

Attach threaded beams to the front of chassis. These will hold the steering drive.

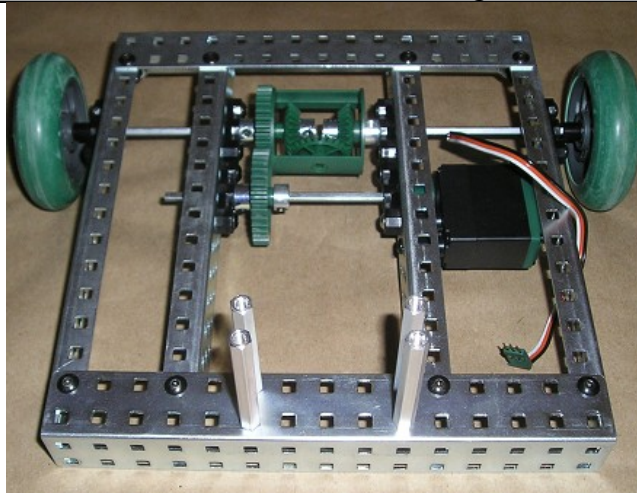
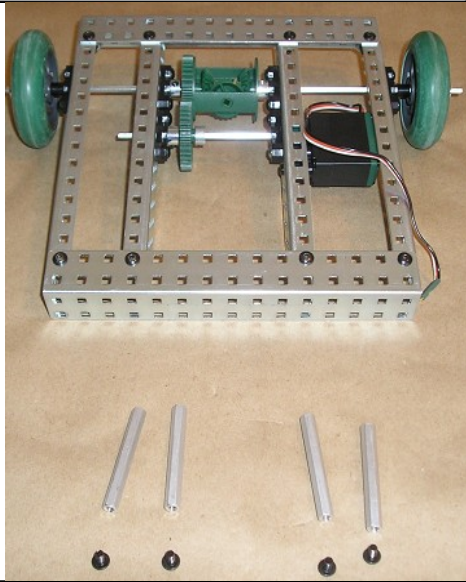

Assemble supports for the steering wheel.

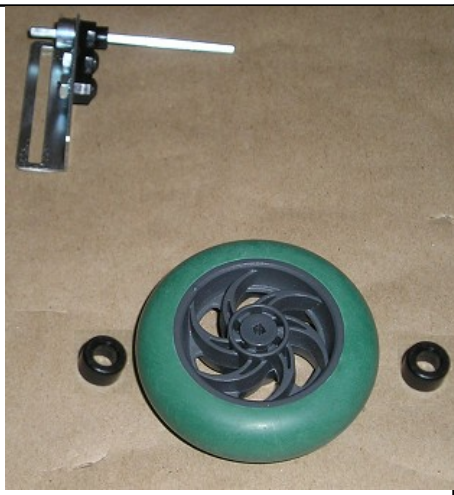

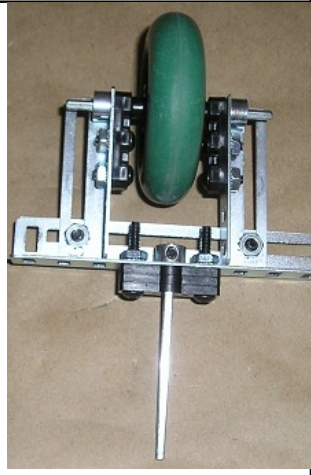
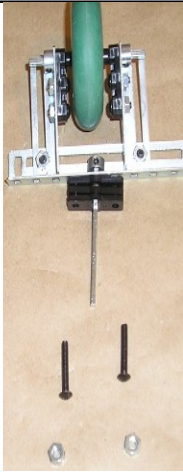
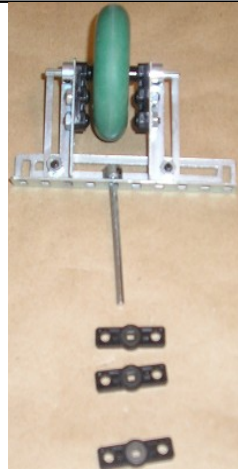
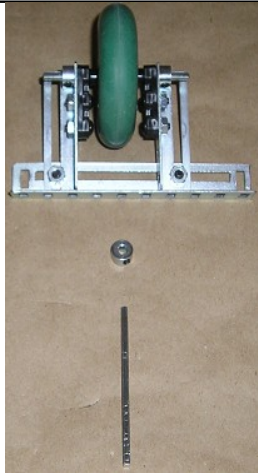
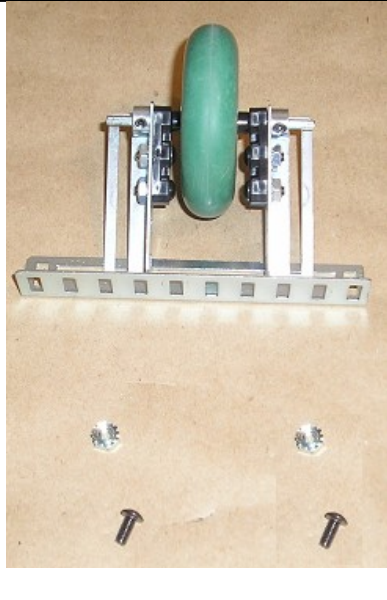
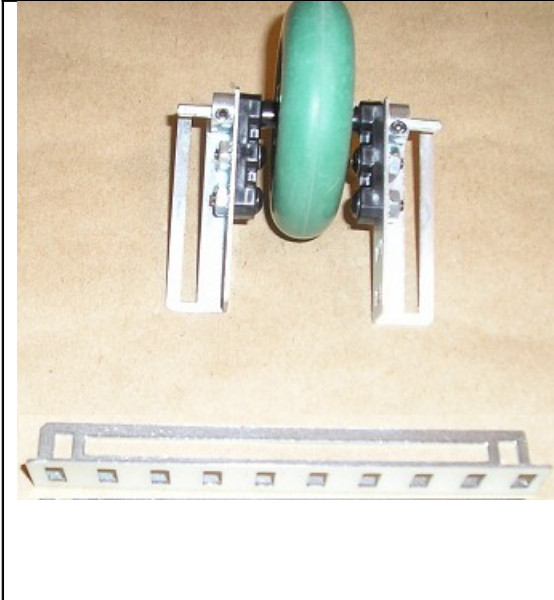

Mount the steering wheel onto a plate, which enables attachment of servo (do not use a continuous motor module here).

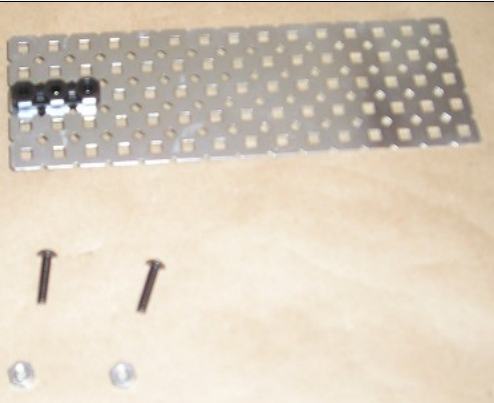
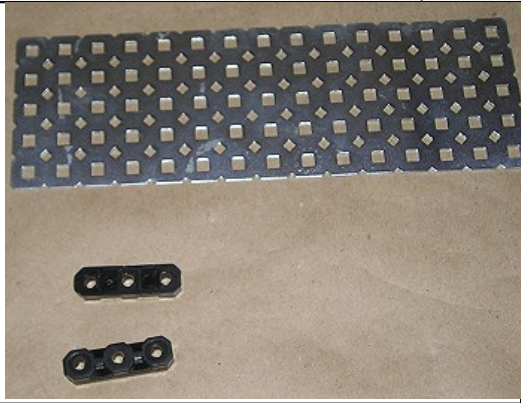

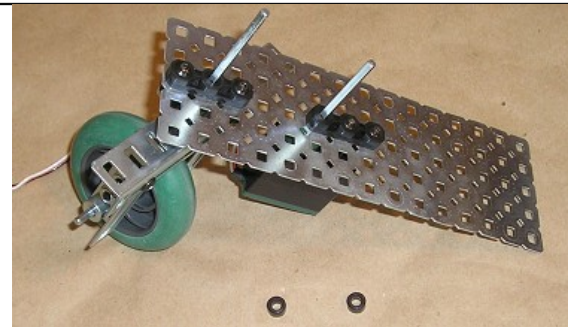
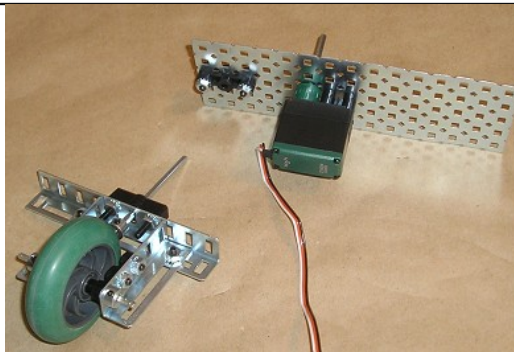
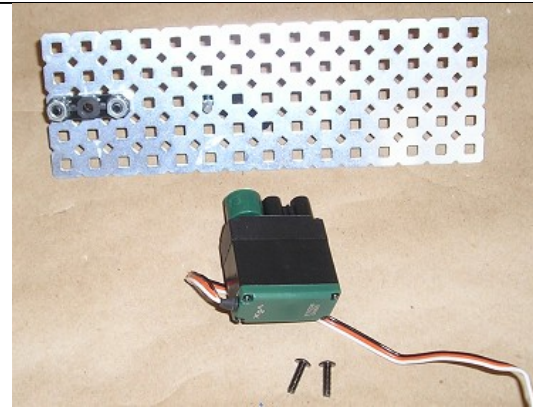
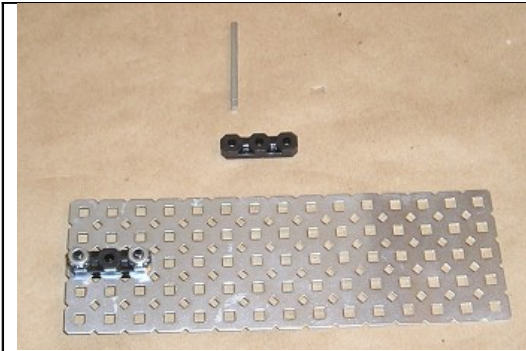

Attach sprockets and chain. It is very difficult to attach the chain while the sprockets are on the axles without getting "slop" in the chain. To minimize the slack, estimate the correct chain length and snap it into a circle, feed it around the sprockets, and place the sprockets on the axle last, pulling the chain taut. If necessary, add or remove a link or 2. Align sprockets so that the steering wheel is approximately centered when the servo is in "resting" position.

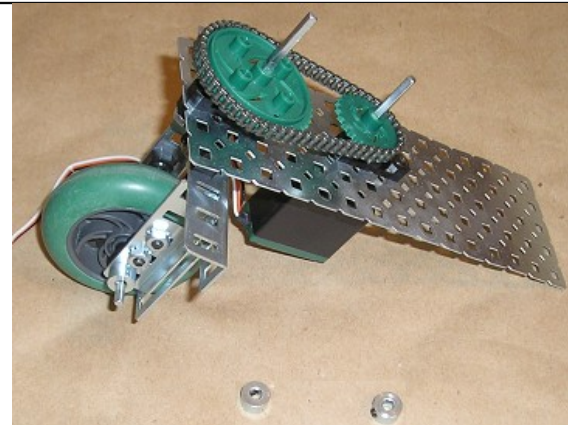
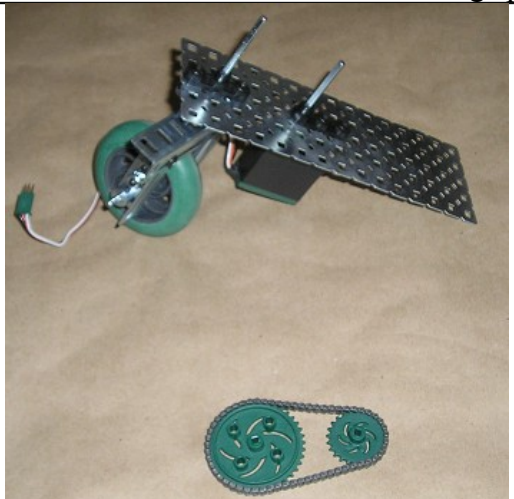

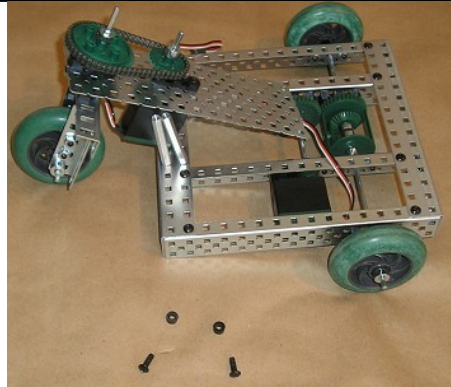
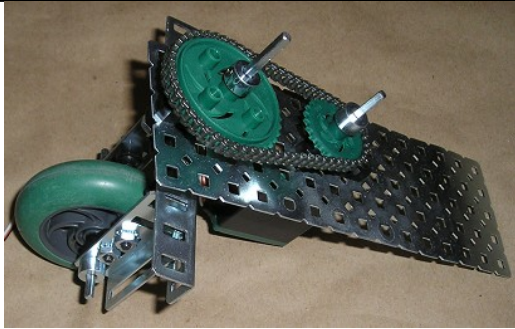

Attach steering wheel assembly to chassis using threaded beams on both sides.

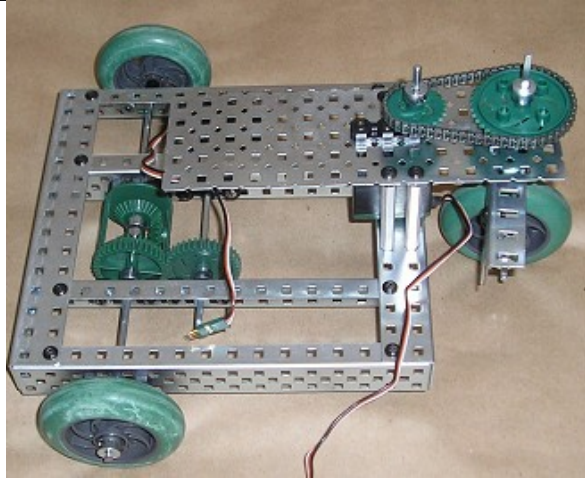

Attach microcontroller, RF module, antenna, and battery. Plug drive motor into motor port 3, steering motor into motor port 1.

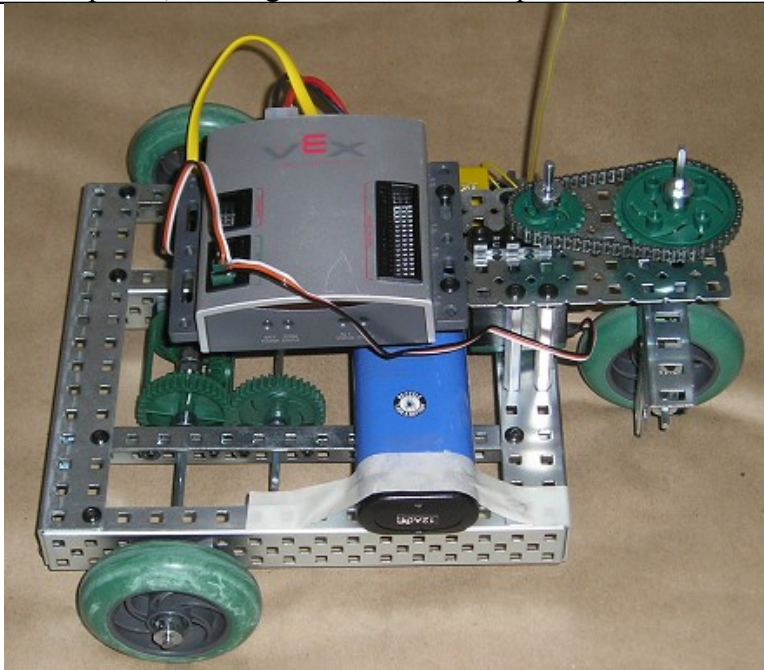

Project Notes and Engineering Principles:

Steering Drives

Many simple robots are constructed with one motor on each side, using the difference in speed for turning (these are called *differential* drives). Thus, the same motors are used for controlling speed and direction. However, when you think of how a "real" car is driven, only one control (the gas pedal) is used to drive forward, and a separate control (the steering wheel) is used for steering. A robotics car-type drive (whose steering mechanism turns the 2 front wheels) and a tricycle drive (with a 1-wheel steering mechanism) use this principle.

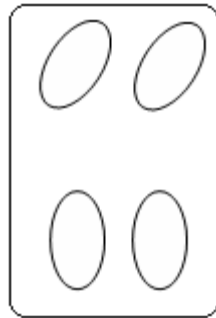

Car-type Drive

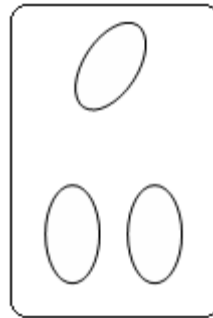

Tricycle Drive

In order for a car to turn, the inside and outside rear wheels must travel at different speeds. With only one mechanism controlling forward motion, how is this possible? One way is to use a *differential* or *differential gear* (not to be confused with a differential drive which uses 2 motors). A differential distributes unequal amounts of "spin" to the 2 axles on either side. Watch the motion of the axles in the differential as your steering drive turns.

One thing to note is that this drive does not accurately mimic the behavior of a car: in a car, the front wheels are used for both locomotion and steering, whereas in this tricycle drive configuration the back wheels are used for locomotion.

This robot drives "counterintuitive", i.e. pushing the joystick up moves the robot toward you, rather than away. This problem can be fixed in a number of ways, including 1) rebuilding the robot as a mirror-image, 2) reprogramming the channels in the software, reversing the direction of the motors, or 3) reprogramming the transmitter.

Chain and Sprocket Uses

In this project, the chain and sprockets are used to transfer motion from one place to another. Gear trains also accomplish this, but a big advantage of using chain and sprockets is that a desired gear ratio can be maintained without being limited by the size of the gears – the 2 axles can be close together or far apart, and the distance doesn't have to be an exact multiple of a certain gear size. The main disadvantage is that chain is quite fragile and is likely to break in a competition environment, especially if it is exposed and taut. Use sparingly.

Cup Crusher

Project Description: Device translates a motor's rotational motion to linear motion capable of crushing a cup.

Kits Needed:

- 1 Starter Kit
- 1 Advanced Gear Kit

Cut Pieces Needed:

- 2 angle bars, 5"
- 2 angle bars, 2 ½ "

Bill of Materials

1 microcontroller 1 RF module 1 battery 1 motor module 1 plate 5 X 15 holes 1 plate 5 X 10 holes 1 plate 5 X 9 holes (5 X 10 also OK) 4 angle bars, 2 ½ " 2 angle bars, 5" 4 rack gears 6 bearing flats 2 gussets 2 chassis rails	1 square bar, 5" 1 square bar, 4" 1 square bar, 3" 7 collars 1 worm gear 1 large gear (60 tooth) 2 gears, 24-tooth 2 long motor screws 12 short motor screws (for rack gears) 27 medium/long screws 27 keps nuts 3 large spacers 1 small spacer 6 plastic washers
---	--

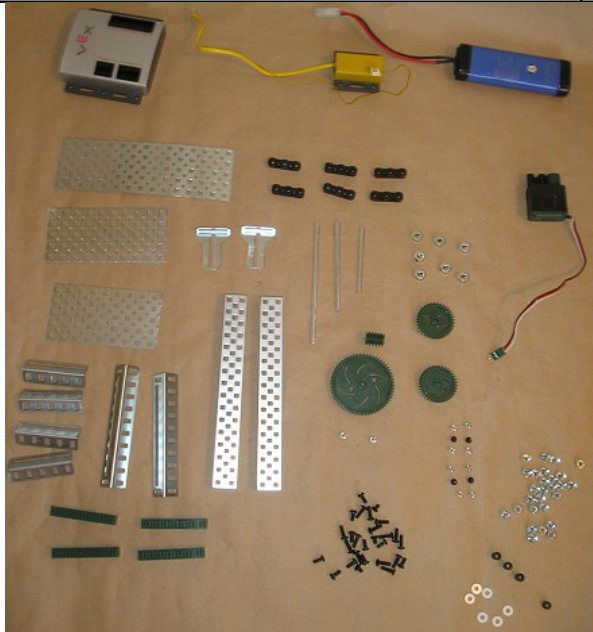

Build Sequence

Attach gusset to 9 X 5 hole plate (a 10 X 5 may be used for a more symmetrical, equally functional design, with plate extending an extra row beyond the edge of both gussets). Align another gusset on right, but do not attach.



Turn plate upside down. Attach bearing flats as shown.

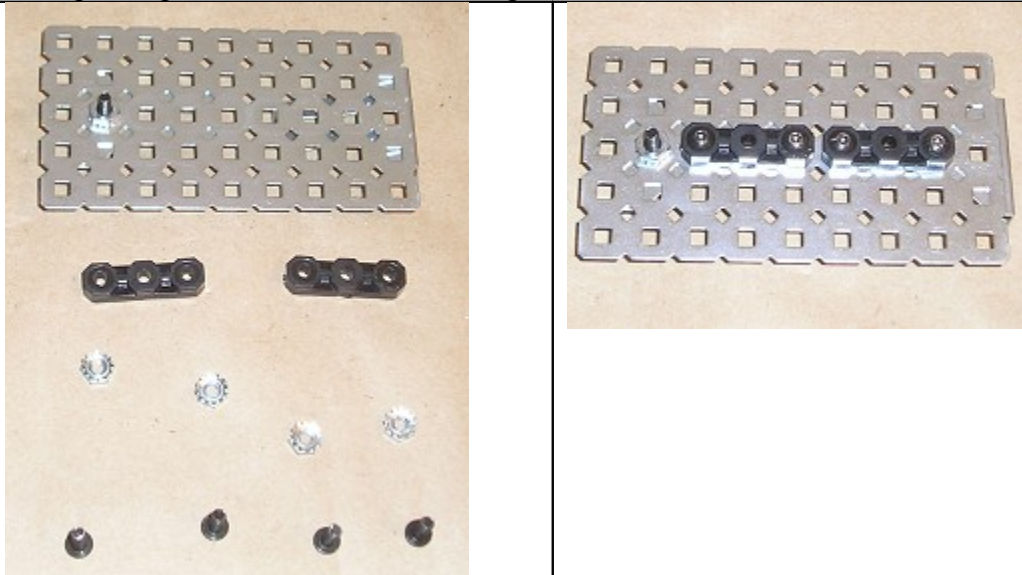

Turn plate right-side up and attach 2 ½ " angle bar.

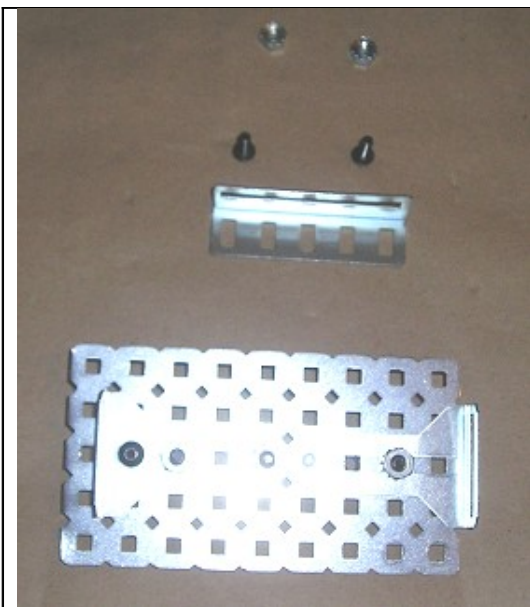

Attach 2 1/2 " angle bar to motor.

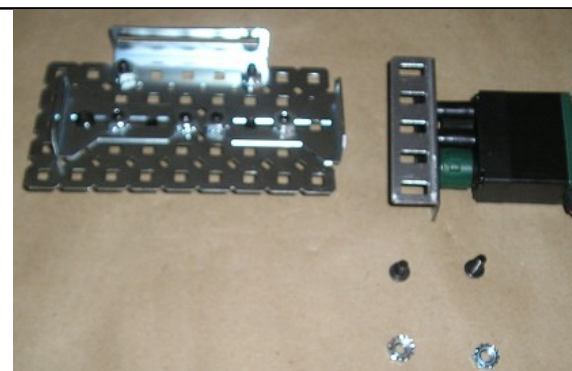

Attach bearing flat to 2 1/2 " angle bar, and attach angle bar to plate.



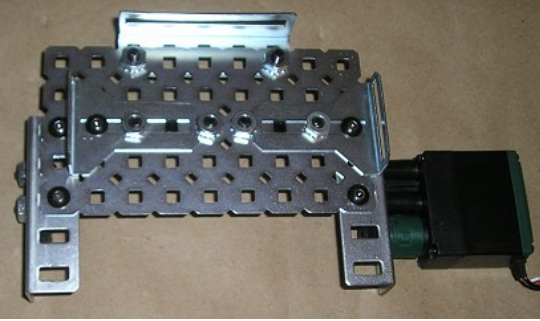

Slide axle into motor, with worm gear and anchoring collars as shown. These will be readjusted when the large gear is placed.

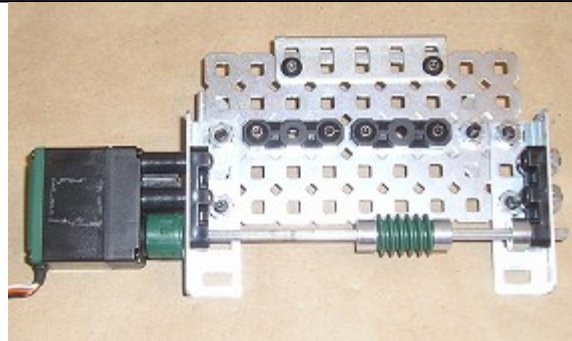
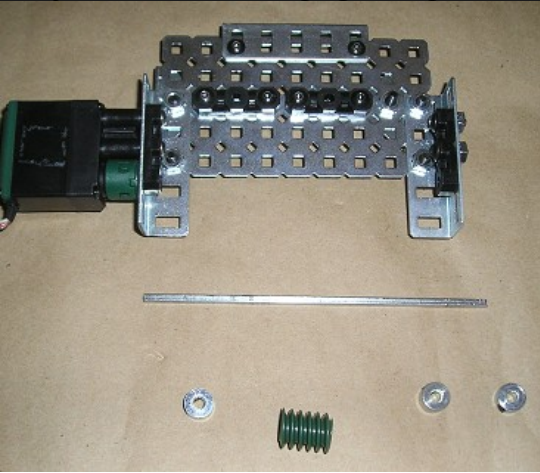

Attach rack gears to the middle row of holes in chassis rails. Connect racks loosely to slotted portion of angle bars – the width of the frame will depend on the nesting of gears, which will not necessarily correspond exactly to a fixed hole position.

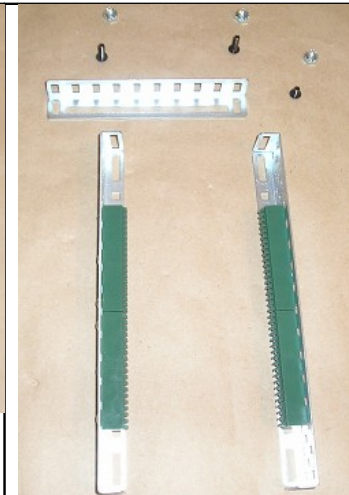
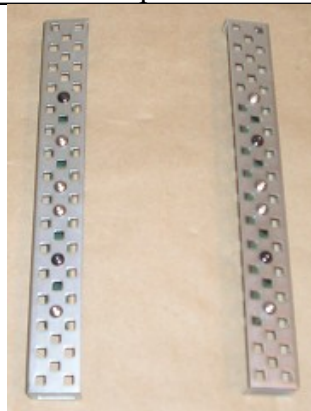
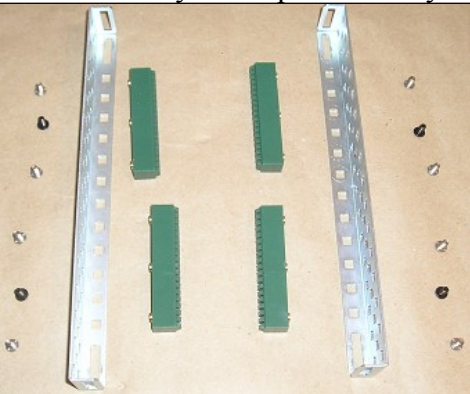

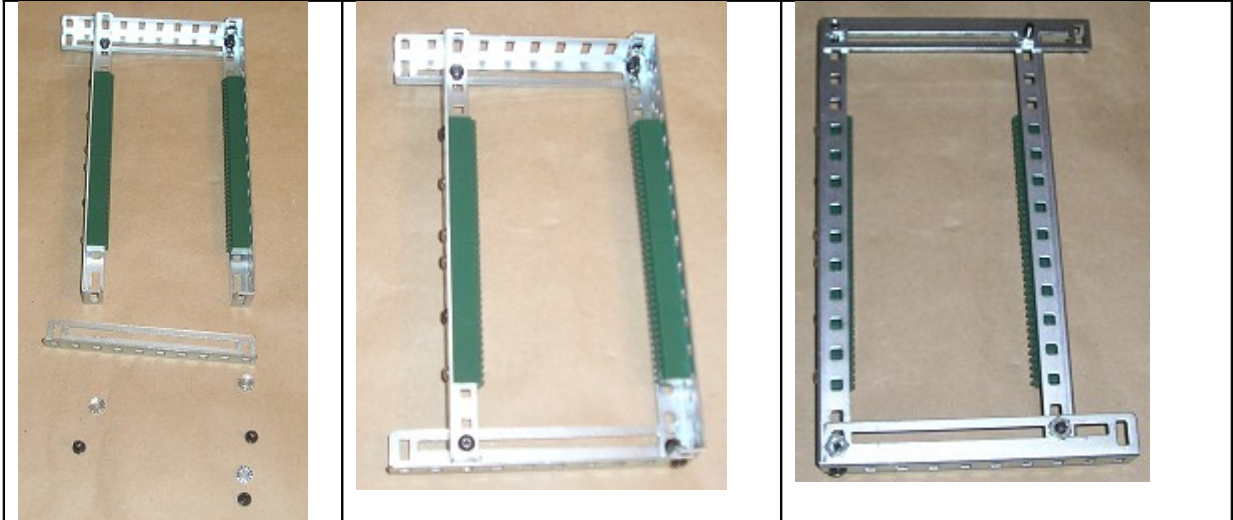

Place rack inside gusset edges, adjusting the width of the frame so the center plate slides smoothly along the sides of chassis rails. Place axles in bearing flat holes, add large spacers and 24-tooth gears. Tighten when gears are nested with optimal placement – smooth turning with minimal wobble and minimal friction. Screws in the slots will need to be very tight, as more slippage occurs in the slot than would occur with holes.

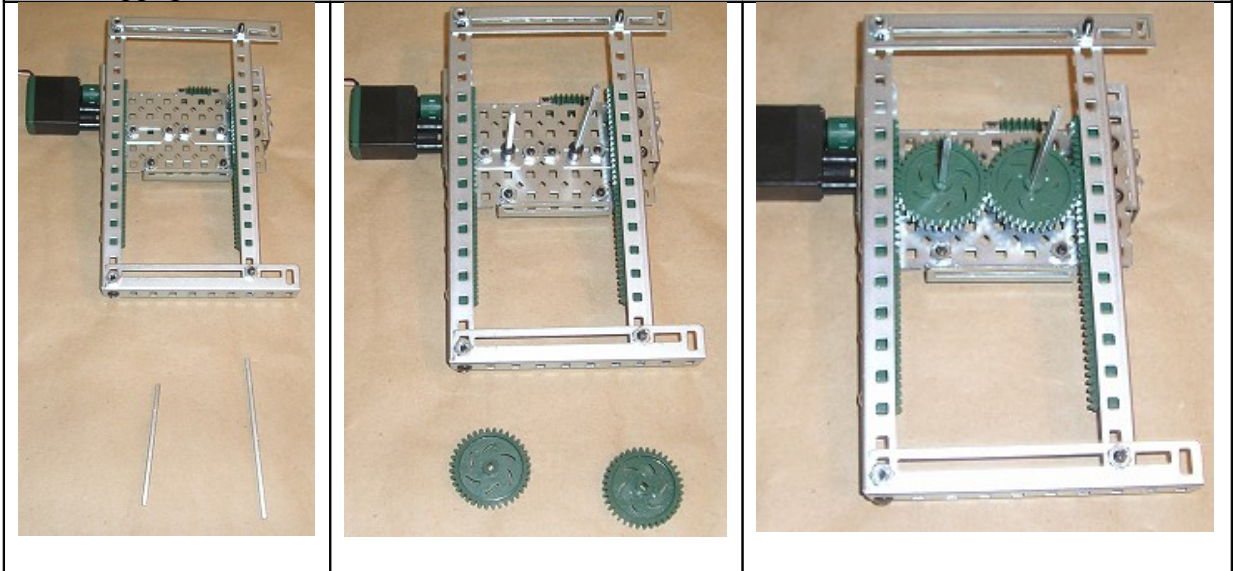

Attach bearing flats to 5 X 10 hole plate, leaving center holes open.

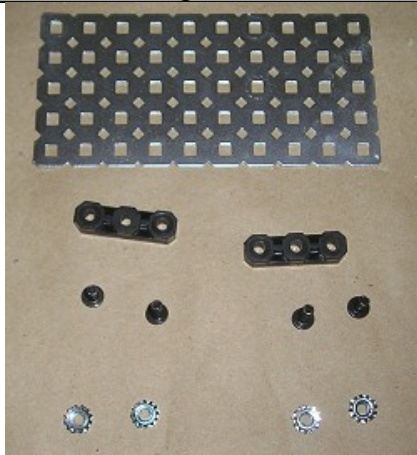

Place 3 plastic washers on each axle. Turn plate upside-down and slide over axles, with bearing flats on the inside.

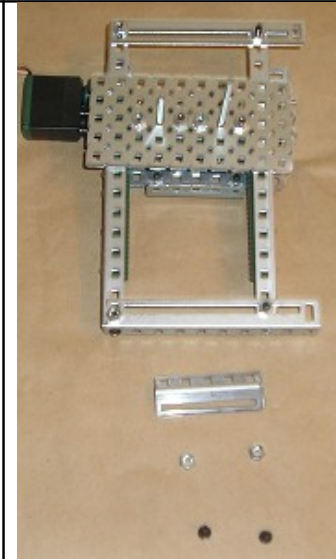
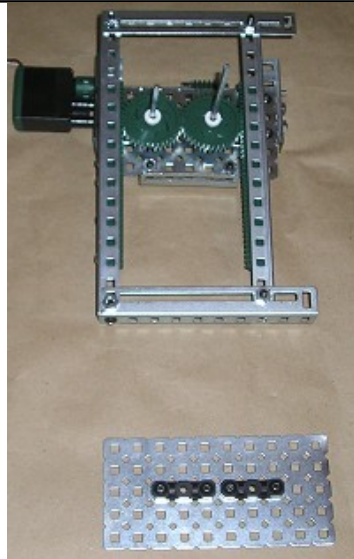
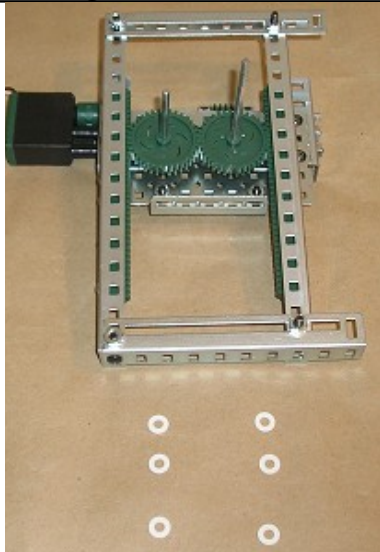

Attach 2 ½ " angle bar to bottom of plate, opposite the angle bar on other plate. Tighten collars on the ends of axles. Flip frame and push axles through.

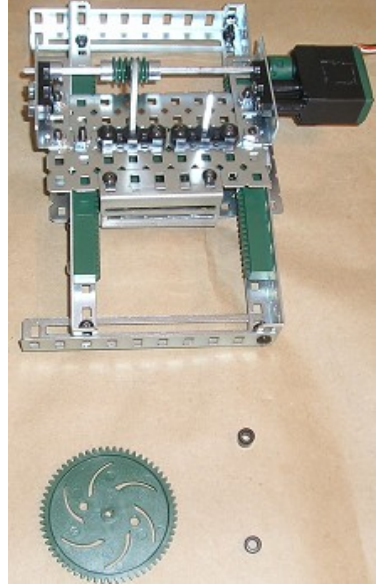
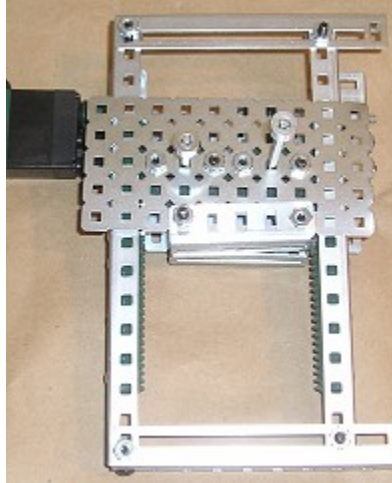
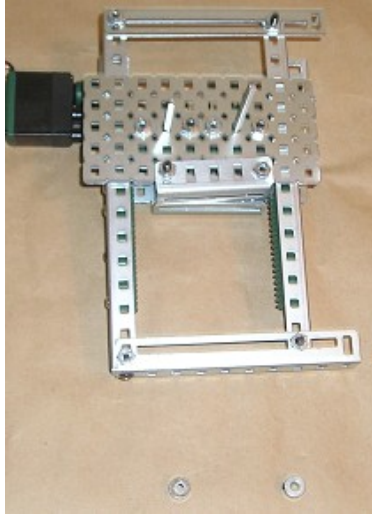

Place large (60-tooth) gear on left axle, and spacers (1 small, 1 large) on the right axle (these are used to prevent the gear from rubbing on the right collar). Anchor the gear and spacers with collars. Adjust the position of the worm gear so that the large gear nests properly. Tighten the collars on the sides of the worm gear – these will have a tendency to slip if not properly tightened.

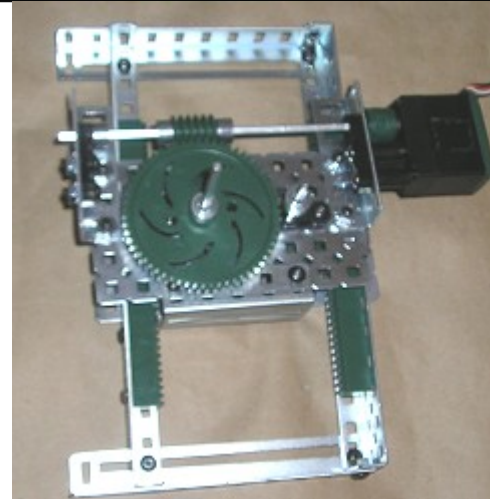
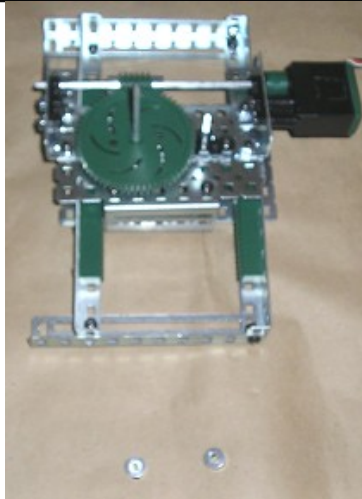

Add a plate to the bottom so the device stands up.

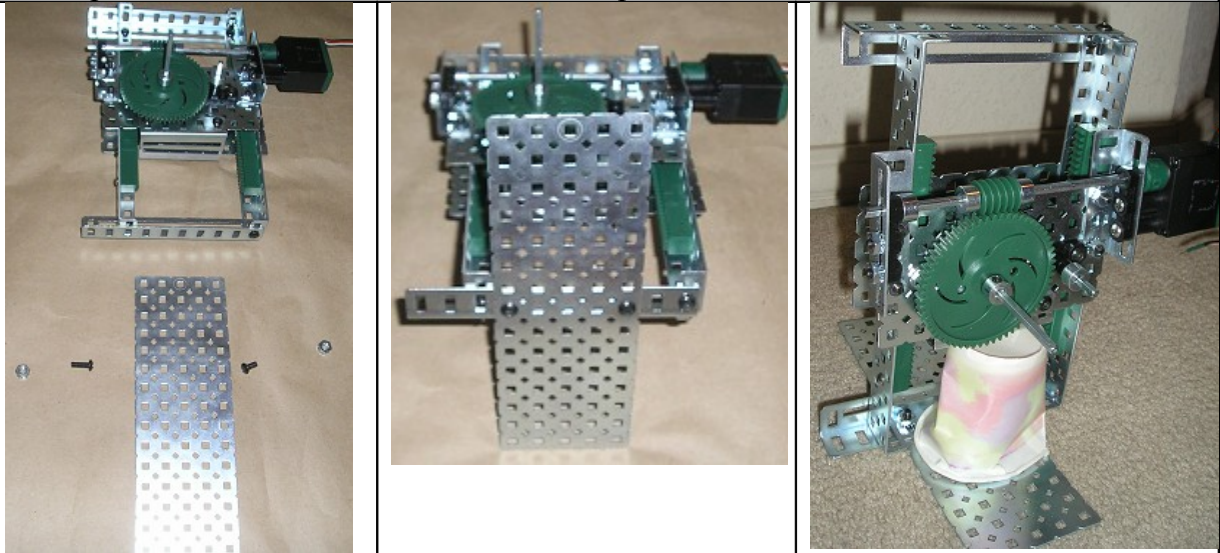

Attach motor to microcontroller motor port, battery, and RF module to operate with the transmitter. There is sufficient torque to crush a paper or Styrofoam cup.

Project Notes and Engineering Principles:

This project demonstrates the use of a *rack and pinion* system which translates rotational motion from the motor to linear motion, with the circular pinion engaging teeth on the rack gear.

The worm gear is used to greatly gear down the motor. The worm gear operates like a screw, with each full rotation of the axle causing the gear to advance by one thread. With the threads nested between the teeth of the 60-tooth gear, each turn rotates the large gear by only one tooth, producing a 60:1 geared down ratio. Thus, the pinion system moves up and down the rack quite slowly.

Even with this extreme gearing down and corresponding increase in torque, there is still not enough force to crush an aluminum can. More torque could be produced by attaching a second motor (turning in the opposite direction so that the motors operate in tandem) and/or gearing down even further.

Holonomic Drive

Original design: FVC #3053, '06-'07, Occam's Engineers, posted at <http://www.chiefdelphi.com/media/photos/28621> and photo 28620 (used by permission).

Design modification and build: Alan Chambers.

Programming: Justin Petersen

Project Description: Another alternative driving base, allowing robot to be easily shifted in all directions.

Kits needed:

- 1 Starter kit
- 2 extra chassis bumpers
- 1 Extra Motor
- 4 Omniwheels (large or small)
- 1 Programming Kit

Cut Pieces Needed: None

Bill of Materials

1 micro controller	8 bearing flats
1 RF receiver	8 threaded beams, 3"
1 battery	4 motors
2 plates, 5 X 15	8 short motor screws
4 chassis bumpers	4 axles, 3"
4 chassis rails	4 small spacers
16 short (1/4") screws	4 large spacers
36 medium (3/8" or 1/2") screws)	4 collars
36 keps nuts	

Build Sequence:

Assemble the Chassis

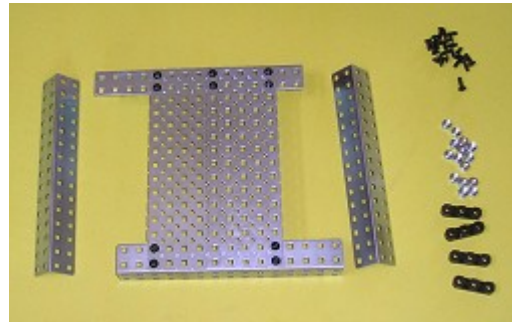
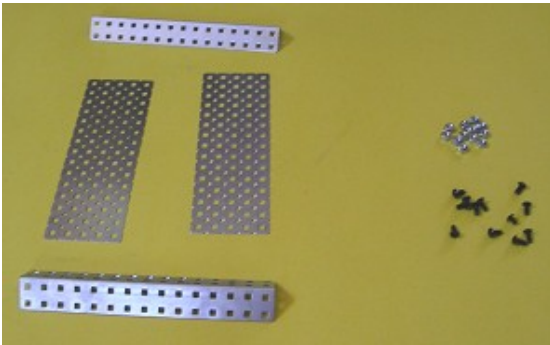

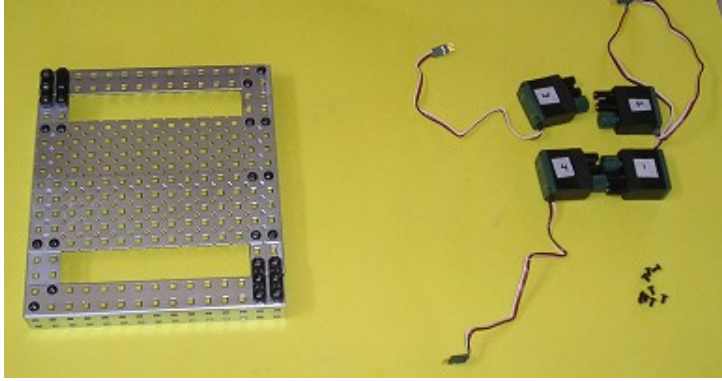
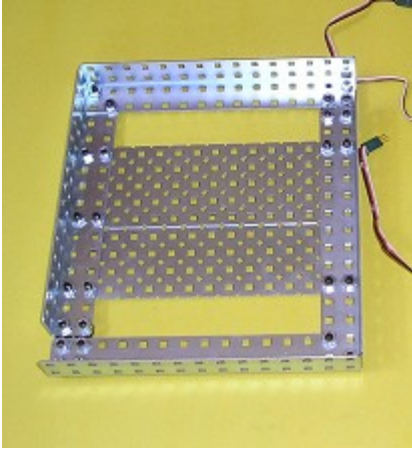

Attach the motors

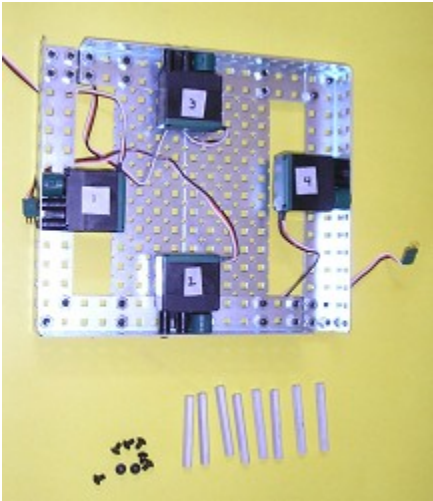

Attach supports and omniwheels

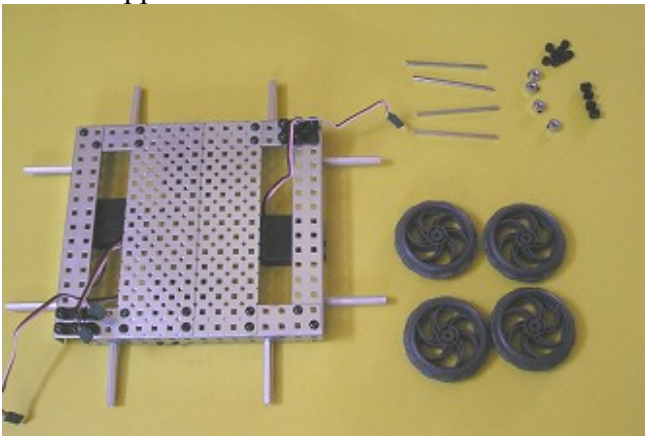

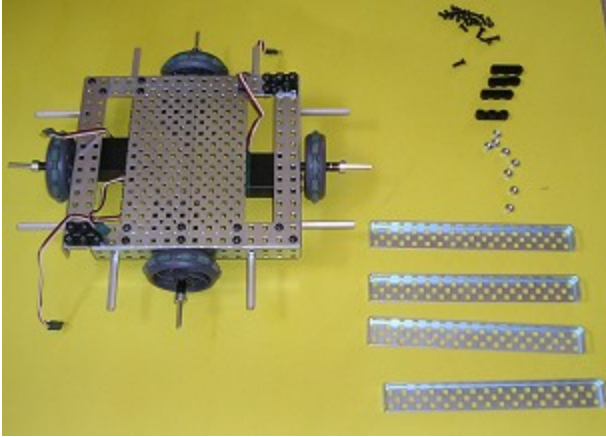

Attach outside rails

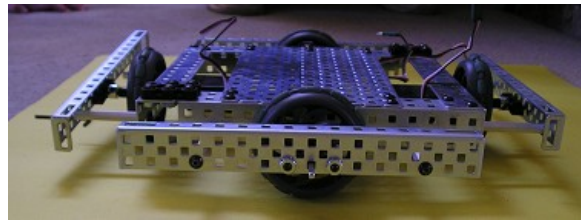
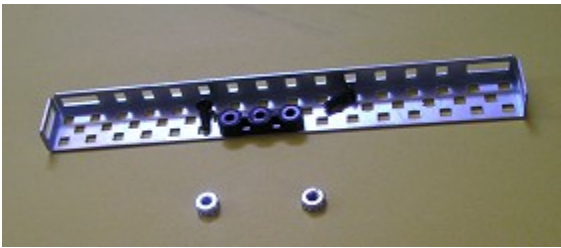

Attach the microcontroller, RF module and battery

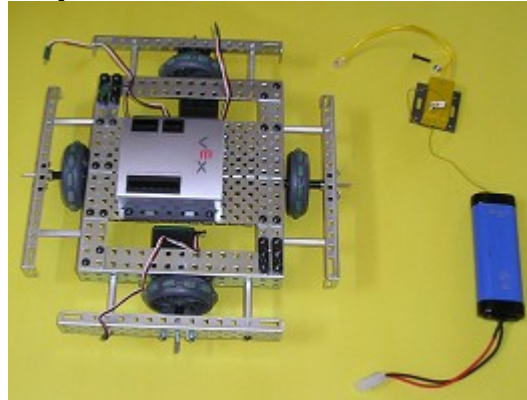
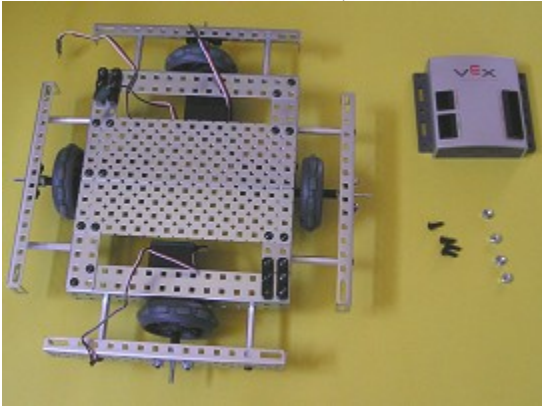

Attach the motor wires - motors labeled 1, 2, 3, 4 plug into ports 1, 2, 3, 4
Viewed from the bottom, the motor numbers go counter clockwise

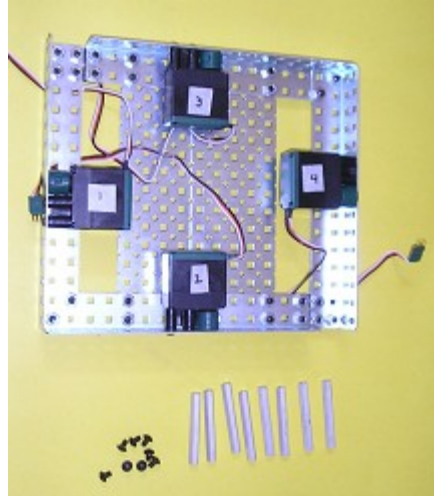
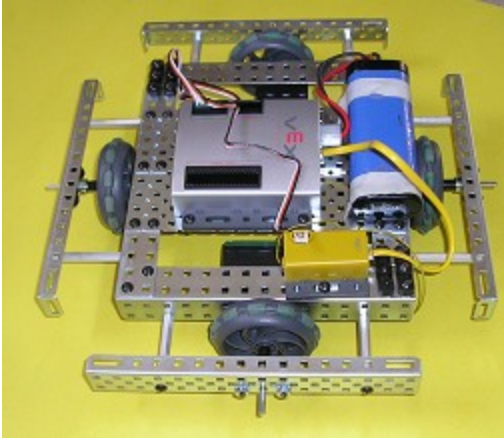

Programming and Operation:

The following program allows the left joystick to shift the bot up/down/left/right.

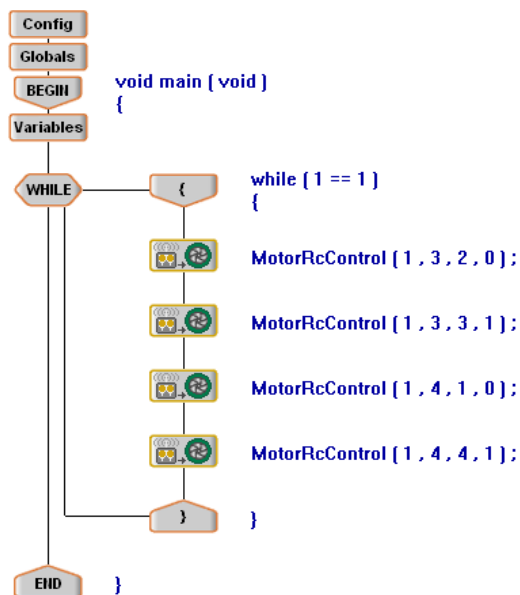

```

1 #include "Main.h"
2
3 void main ( void )
4 {
5     while ( 1 == 1 )
6     {
7         MotorRcControl ( 1 , 3 , 2 , 0 );
8         MotorRcControl ( 1 , 3 , 3 , 1 );
9         MotorRcControl ( 1 , 4 , 1 , 0 );
10        MotorRcControl ( 1 , 4 , 4 , 1 );
11    }
12 }

```

Project Notes and Engineering Principles:

A holonomic drive enables a robot to rotate in place, move in any direction, or do both at the same time. This bot is fairly simple to build and fun to drive. The left joystick is used to shift the robot up/down/left/right. The program included must be downloaded for the drive to work properly.

Further Challenge:

Can you program this bot to spin, as well as shifting in the 4 directions?

Chin-upbot

Design and Build: FVC #3617, Metal Gear ('06-'07)

Project Description: Robot designed to lift itself off the ground from a 30-inch high bar.

Kits & Parts needed:

1 Starter Kit

1 Gear Kit (4 extra 60-tooth gears)

1 Metal and Hardware Kit

1 Extra Motor

Note: An alternative to all these add-ons to the Starter Kit is to buy a second Starter Kit.

Cut Pieces Needed:

3 square bars (axles), 8"

2 square bars (axles), 6"

3 angle bars, 5"

1 angle bar, 7.5"

Build Sequence

Build the Squarebot or alternative driving base (the Flexigearbot is not recommended as a driving base). Remove the chassis bumper on one end.

Construct the arm as follows:

Build supports for the gear assembly:

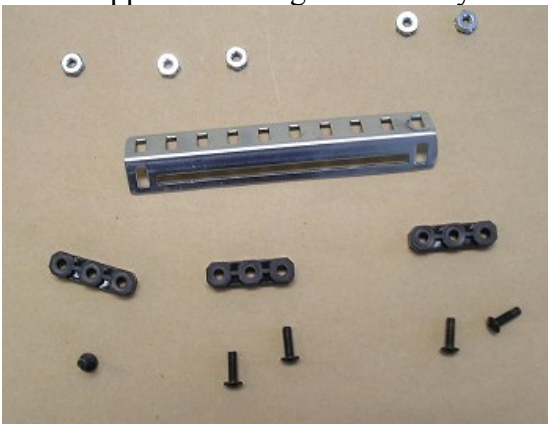

Build the lower joint gear assembly, using the three 8-inch axles.

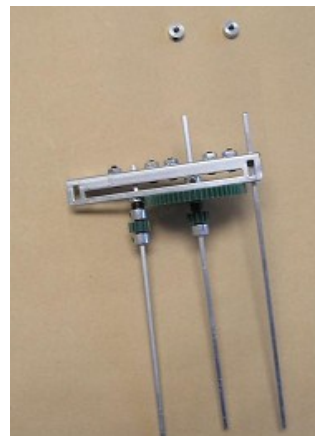
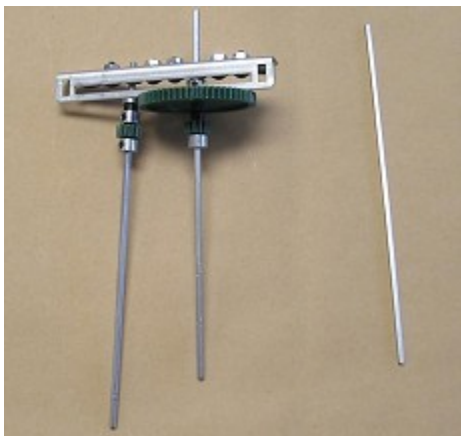
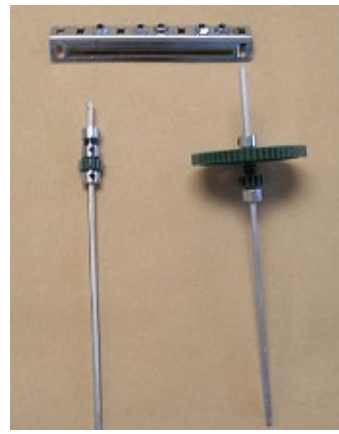
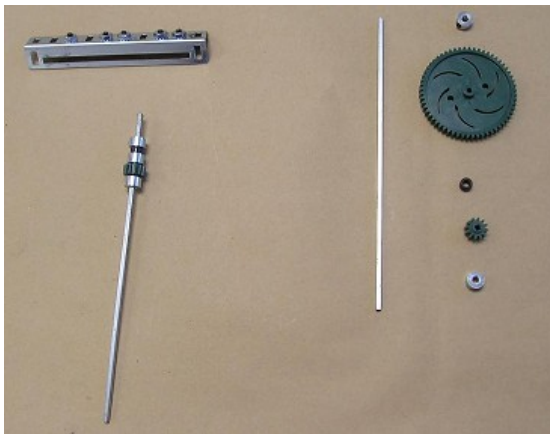
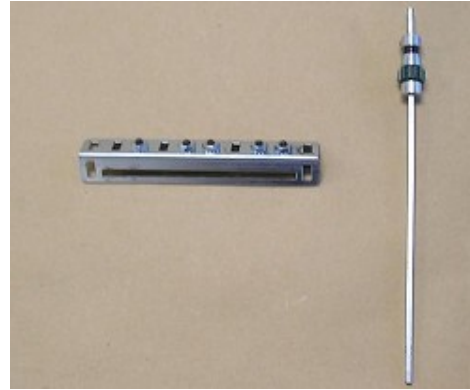
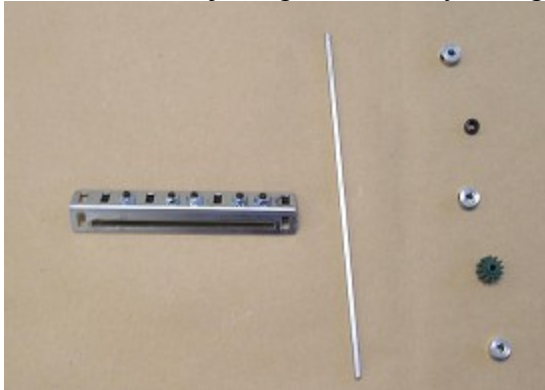

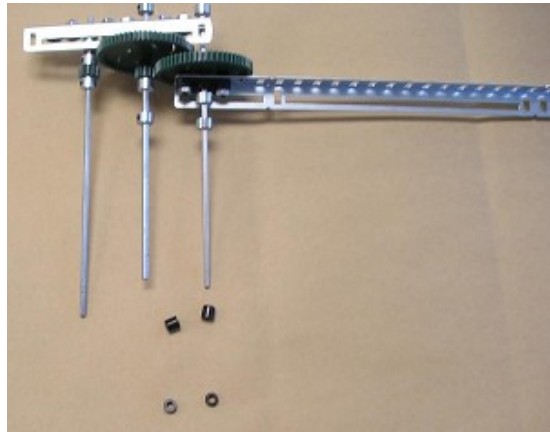
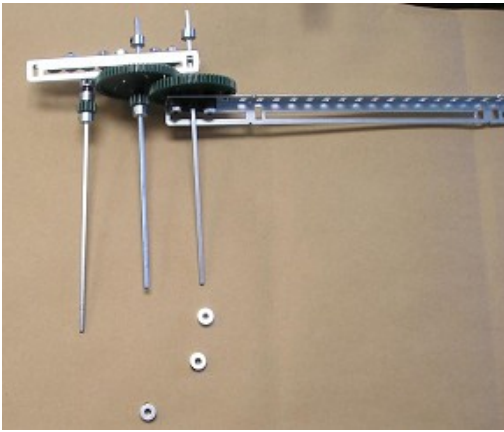
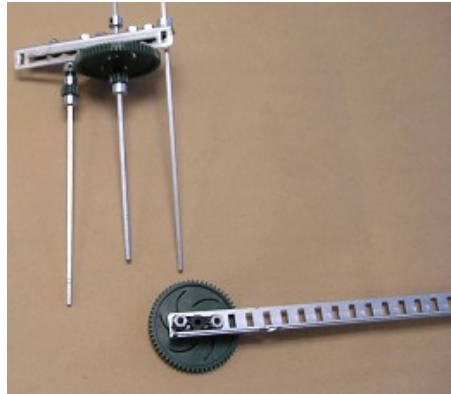
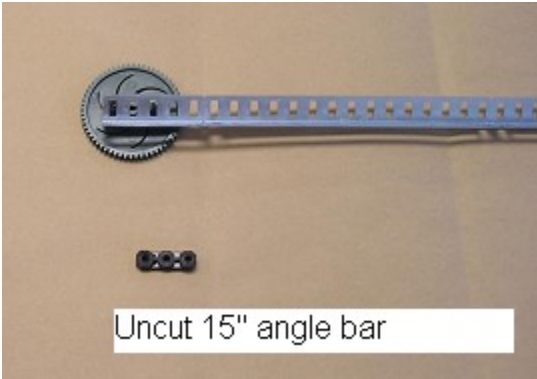

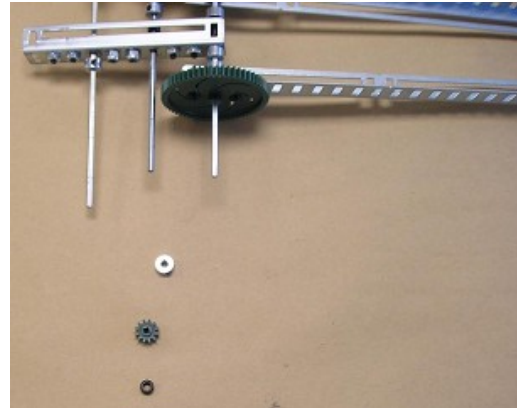
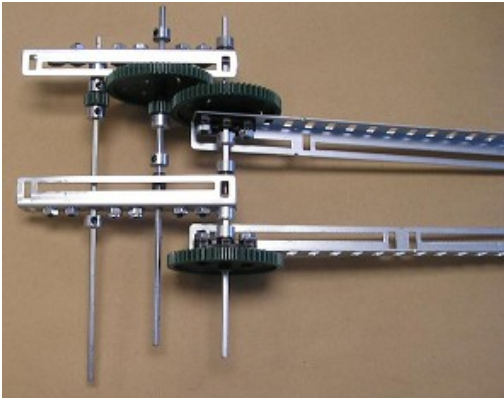
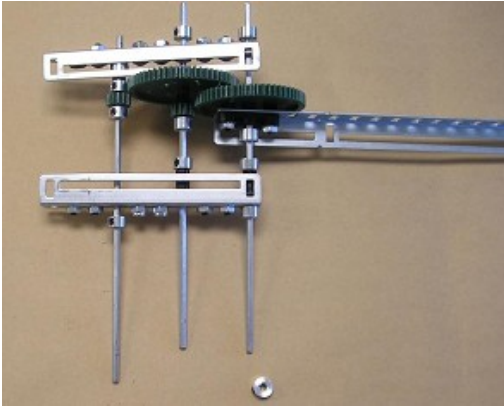
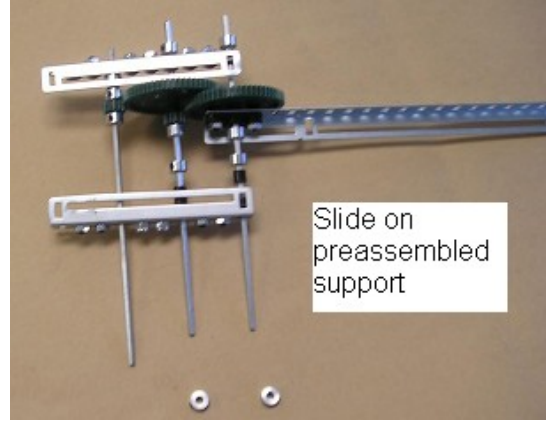
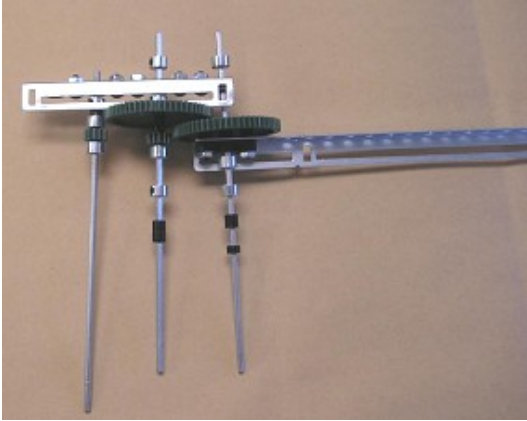

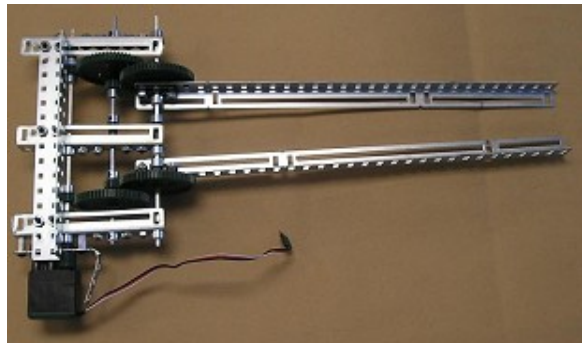
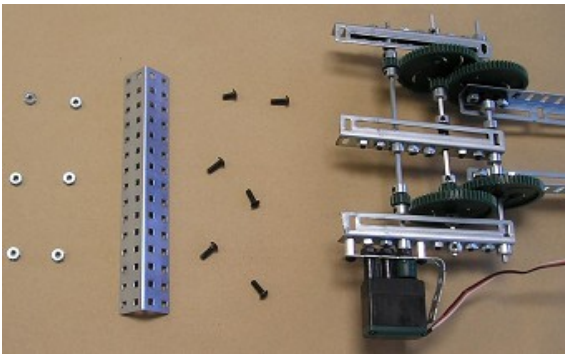
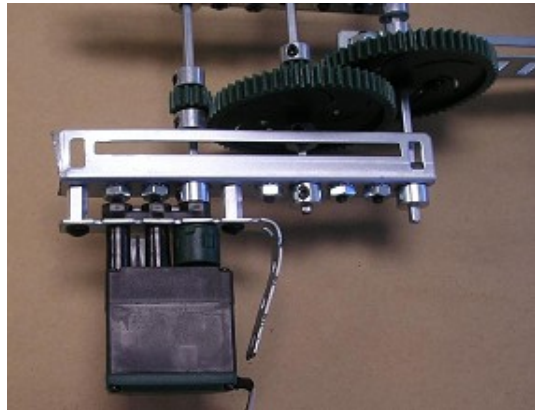
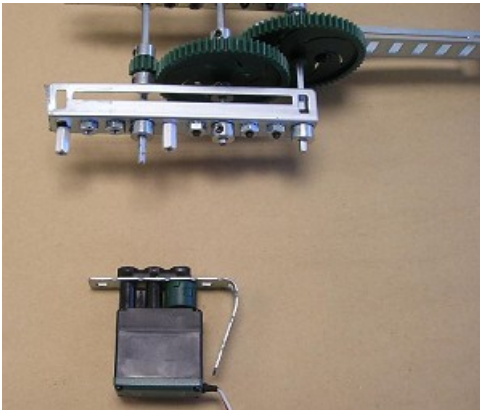
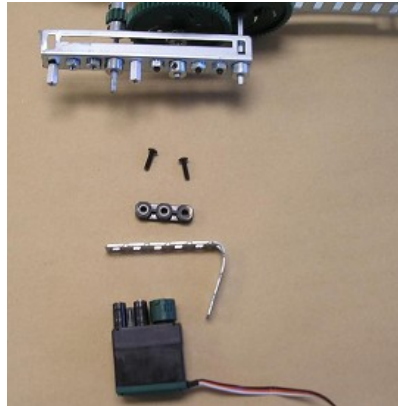
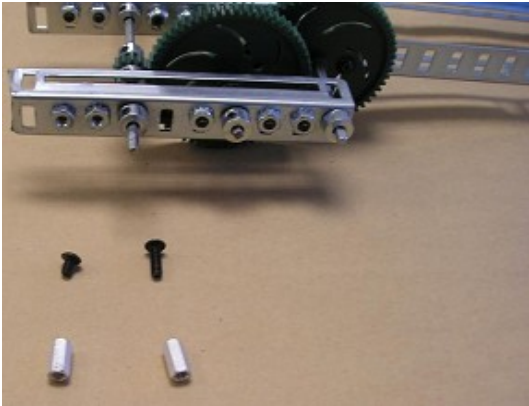
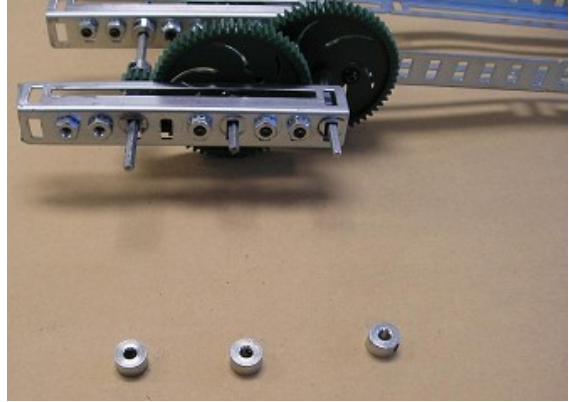
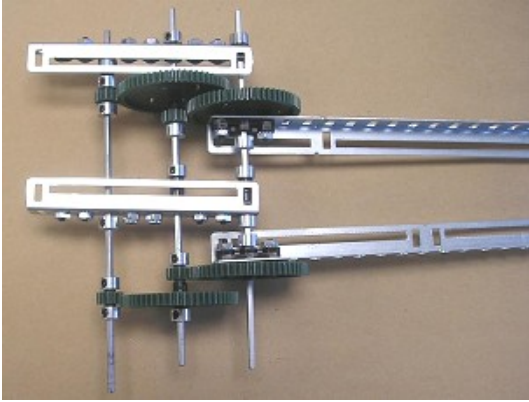

Add the second joint and upper arm

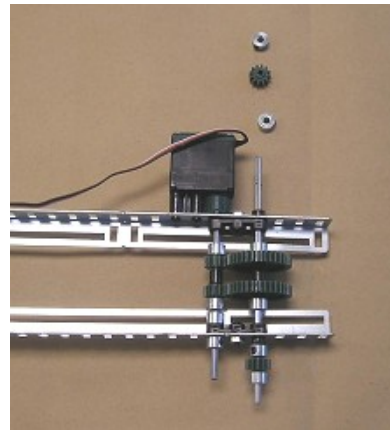
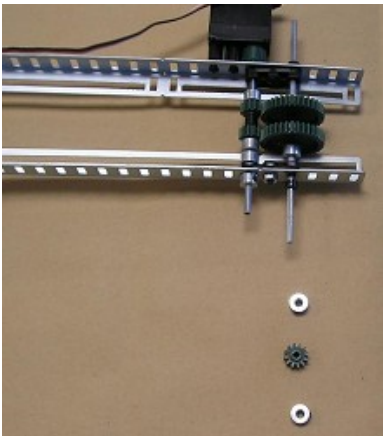
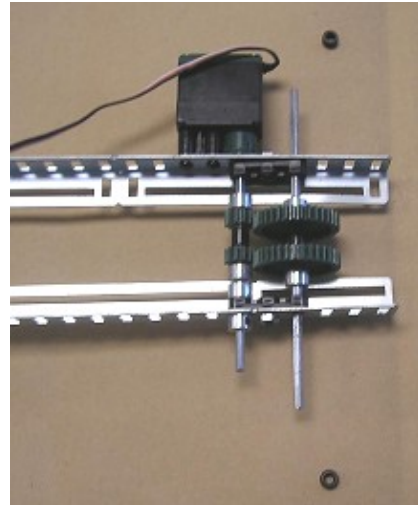
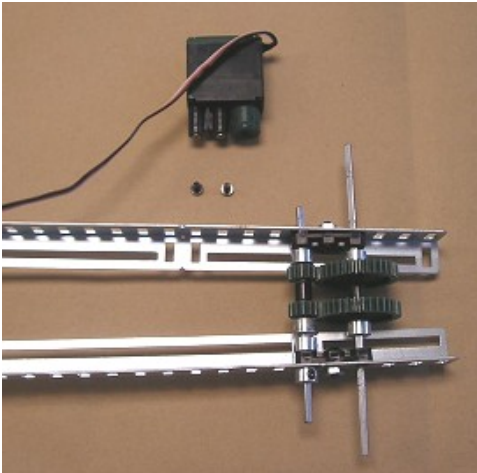
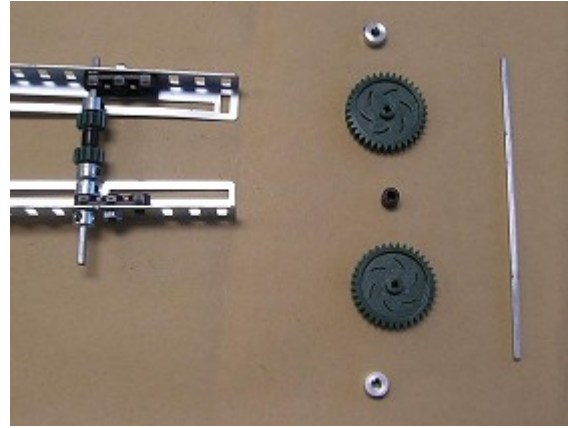
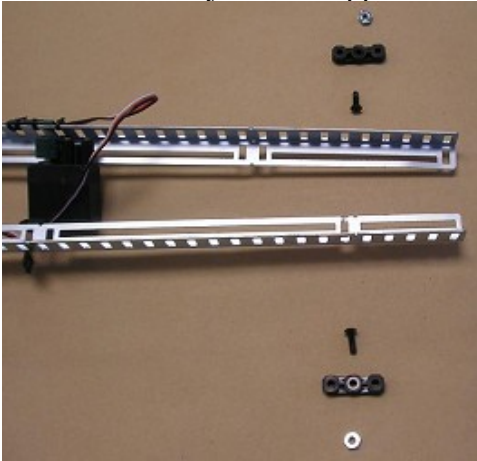

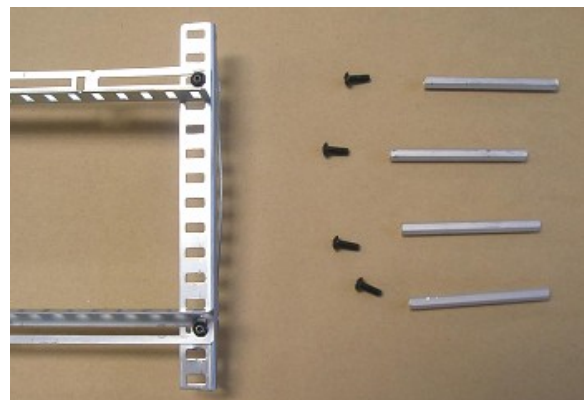
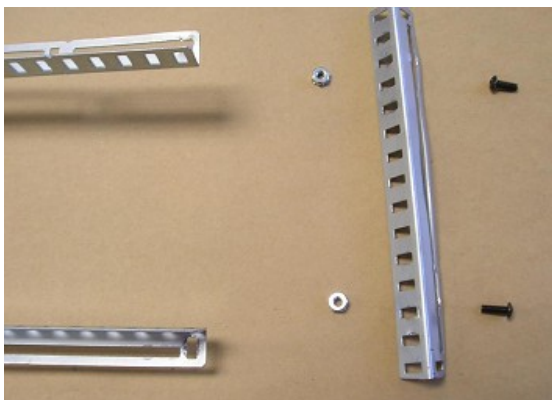
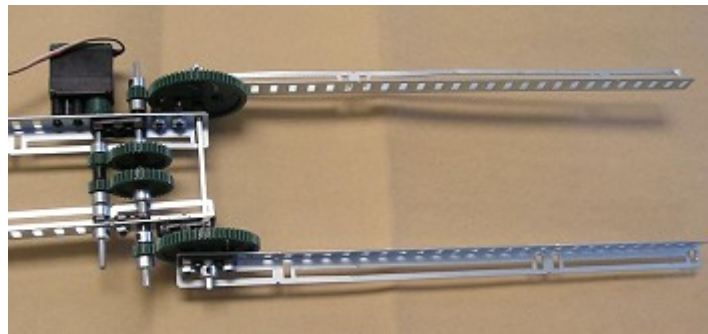
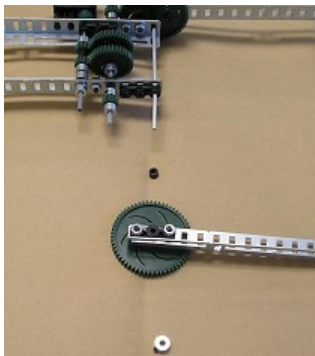
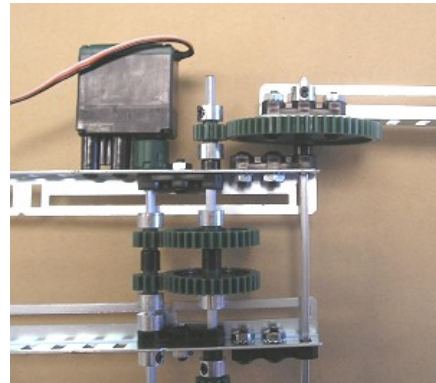
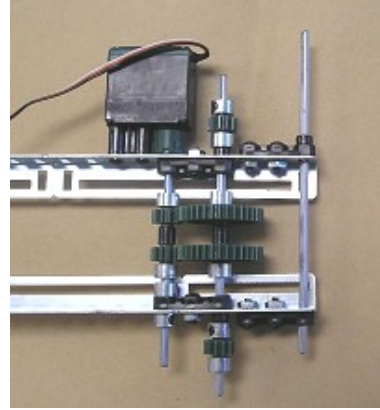
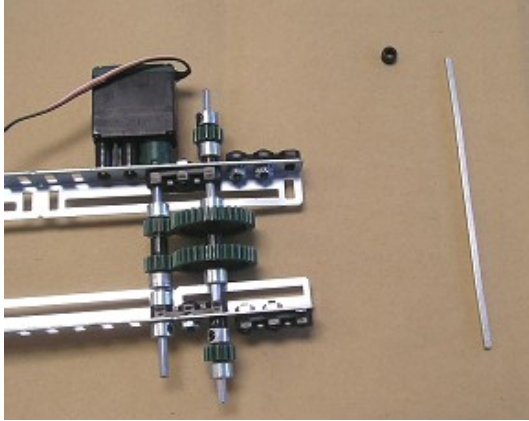

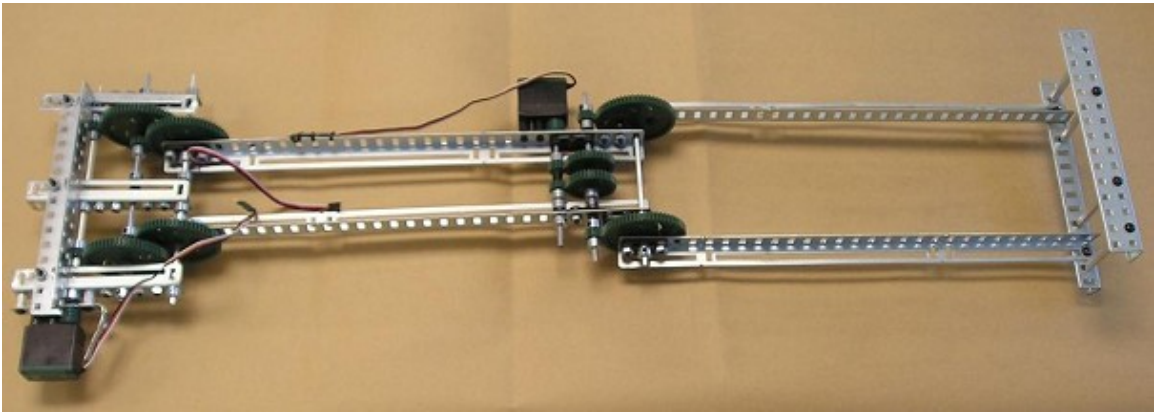
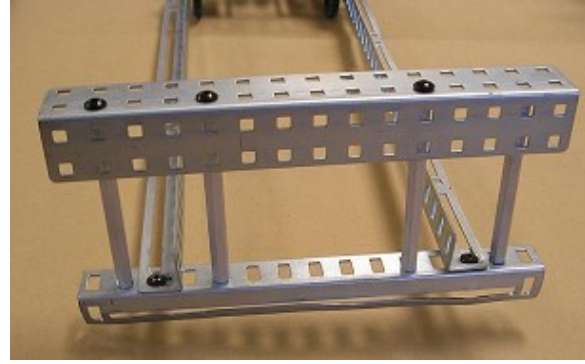
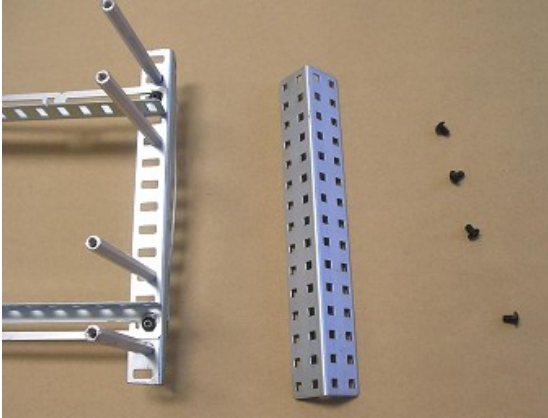

Attach the arm to the robot chassis. This is easier to do if the arm is folded as in the first photo in the chin-up sequence below (plug in the upper arm motor into a motor port and use the appropriate transmitter channel). Plug the drive motors into motor ports 2 and 3, and plug the arm motors into ports 5 and 6 (channels 5 and 6 are the yellow buttons located on the bottom of the transmitter).

To perform a chin-up, unfold the arm, drive the robot forward until it grabs the bar, then fold the lower hinge only to lift the robot off the ground.

Note that this robot is rather unstable (it tips easily) because of the small size of the base and high center of gravity when the arm is extended. A longer driving base would provide more stability.



Programming: none

Project notes and Engineering Principles:

This project uses the Squarebot as a driving base (or you can construct your own driving base). If you have one of these already assembled, simply remove the chassis bumper on one end and use it to build the arm. Thus, the project can be divided into 2 sub-modules (driving base and arm), so that 2 groups of students can work simultaneously. Double gearing (using 2 of the same-sized gears in each joint) is used to increase the surface area that bears the weight of the arm, decreasing the amount of strain put on each gear. Doublewide gears (soon to be available) can also be used.

Multistage Gear Trains

In this project, a gear ratio of 1:25 is achieved by gearing down in 2 stages of 1:5 and 1:5 (sometimes this is reported as "25:1 ratio, geared down"). More than 2 stages (and larger gears) may be used providing even higher gear ratios, limited only by the physical space available. This issue of physical space is not trivial – each gear has a certain width, and there are only so many of them that can be "laddered" along a sequence of axles.

Sometimes it's easy to theorize how a gear train should work, but assembling the actual parts is less than straight-forward. Some things to consider

1. Where will the drive motor go, and where will the final motion take place?
2. How many axles will be lined up (one more than the # of gear reductions), and how will they be supported on either side?
3. How far apart are the axles between each pair of gears? How will the bearing flats on the supports be spaced so that attaching screws don't block the space for axles?

Candy Sorter

Original Design: FTC #548, Geek Squad and FTC #438, Metal Gear ('07-'08)

Modified Design, Build, and Programming: Justin Petersen

Project Description: Conveyor mechanism delivers black and white chips to a sensor, and separates the chips into 2 different containers.

Kits Needed:

1 Starter Kit

1 Programming Kit

1 Tank Tread Kit

1 Metal & Hardware Kit (plus 2 extra 3" threaded beams – optional)

Inverse angle bars (optional)

Cut Parts Needed:

2 angle bars, 10"

3 angle bars, 5"

4 angle bars, 2 ½ "

3 square bars (axles), 4"

Bill of Materials

1 microcontroller	67 tank tread links
1 battery	2 tank tread hubs
1 servo module	1 tank tread roller
1 motor module	3 small spacers
1 line follower sensor	10 large spacers
2 angle bars, 15" (one inverse)	2 plastic washers
2 angle bars, 10" (one inverse)	4 long motor screws
3 angle bars, 5"	31 keps nuts
4 angle bars, 2 ½ "	10 collars
1 chassis rail	61 medium screws, 3/8" or ½"
8 bearing flats	
2 lock plates	
1 plate 5 X 10 (slightly larger or smaller OK)	
1 plate 5 X 9 (slightly larger or smaller OK)	
4 threaded beams, 2"	

Note: For this project, we used one inverted 15-inch angle bar and one 10-inch inverted angle bar. If you have inverted angle bars and can do the same, you'll find maintaining symmetry much easier. However, it is still possible to complete the project without using inverted angle bars.

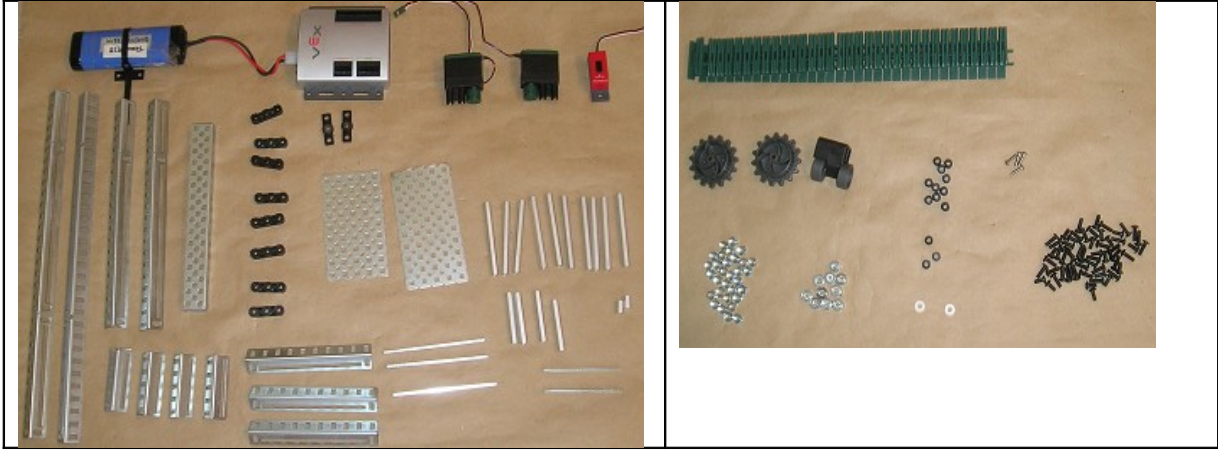

Build Sequence:

Assemble the tank tread assembly as shown below. The tank tread roller is used to keep the tank tread loop as taut as possible. Using as few links as possible is helpful, but there is still some slack even with the smallest number of links.

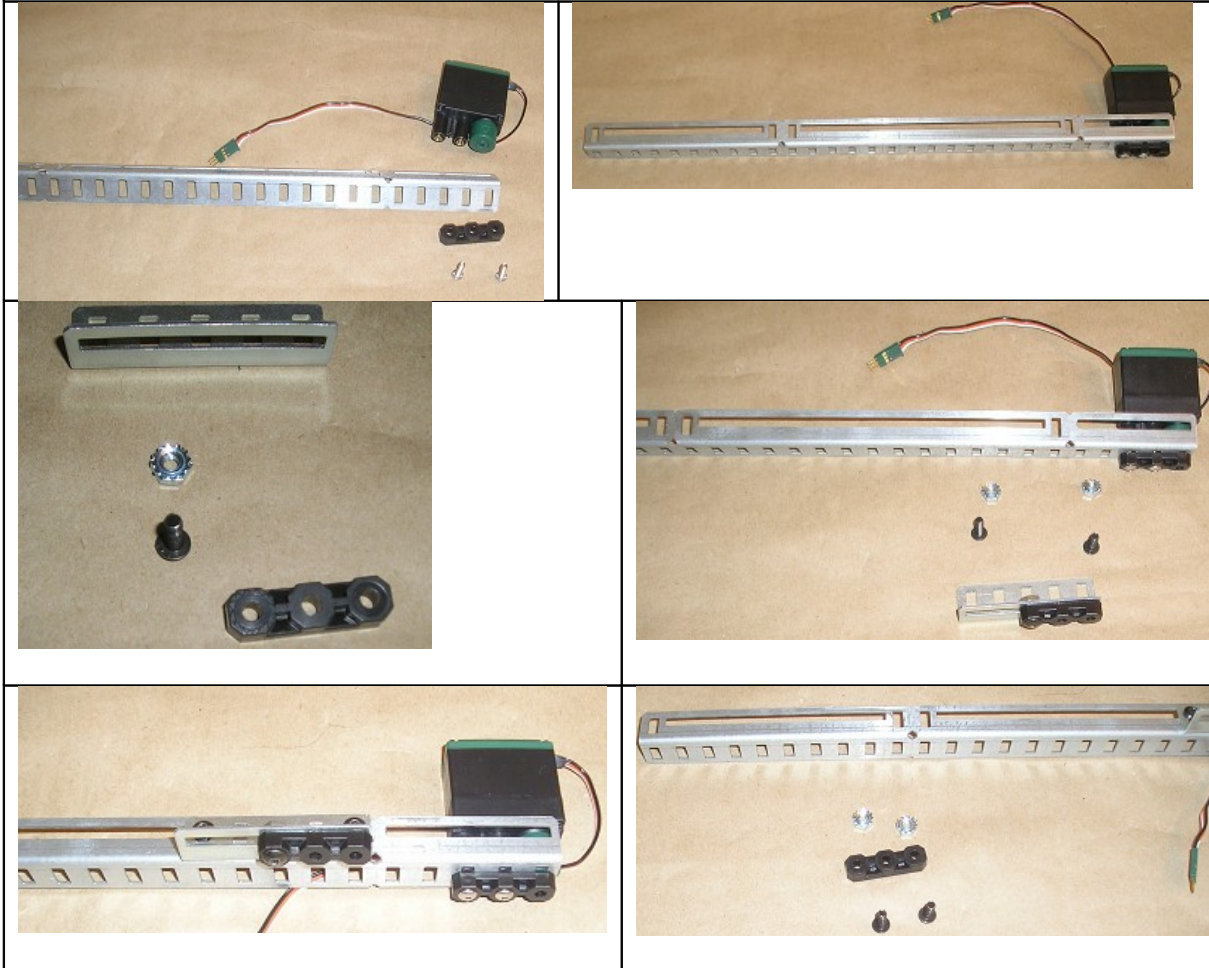

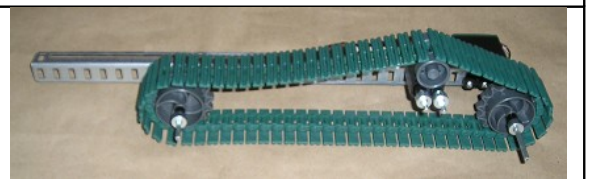
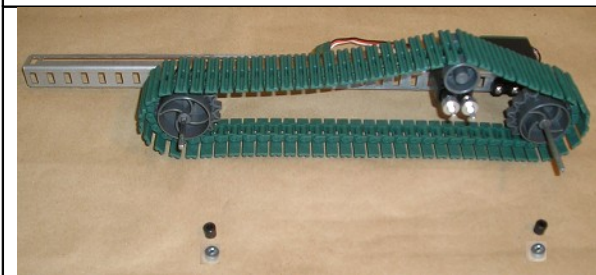
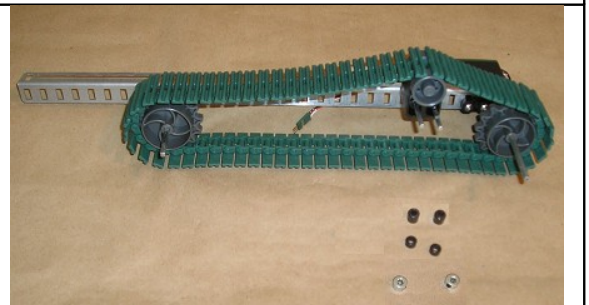
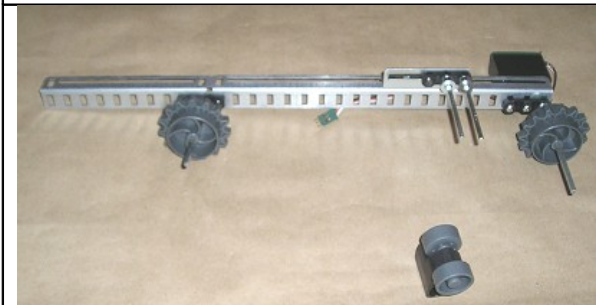
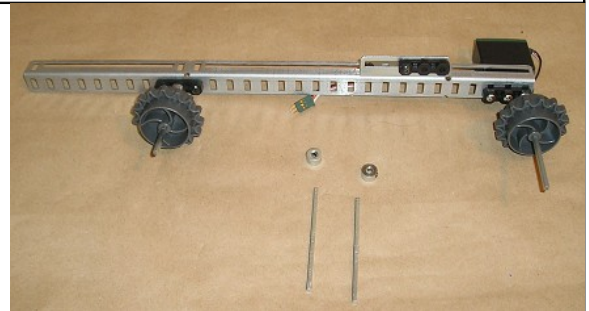
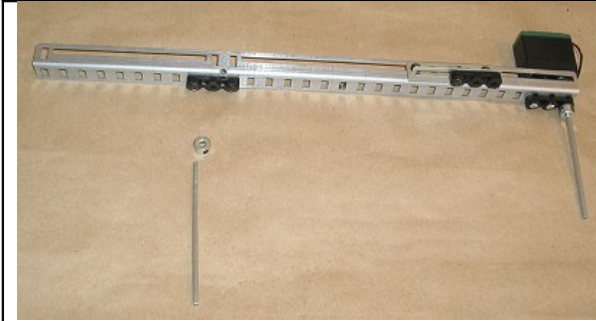
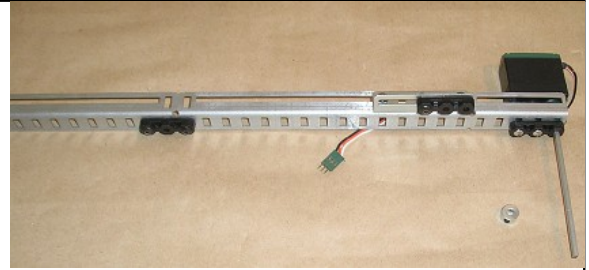
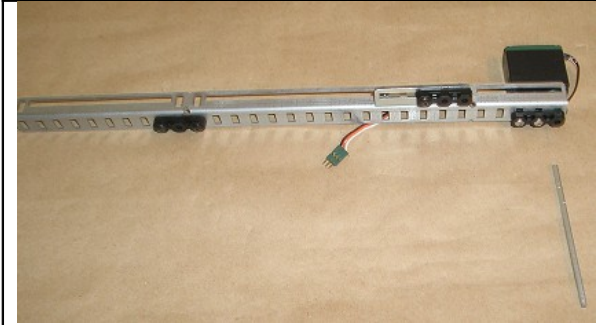

Attach the rail on the opposite side.

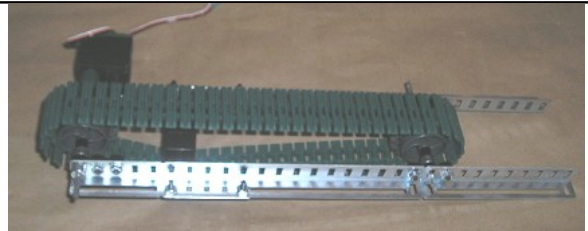
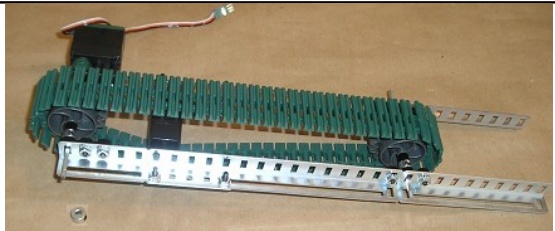
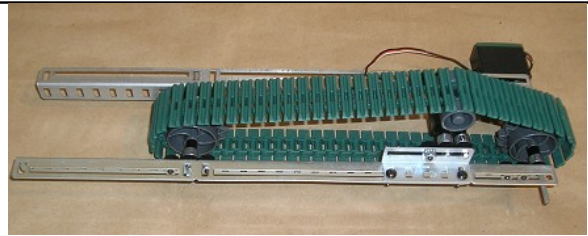
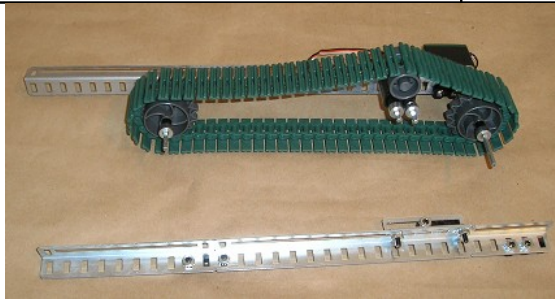
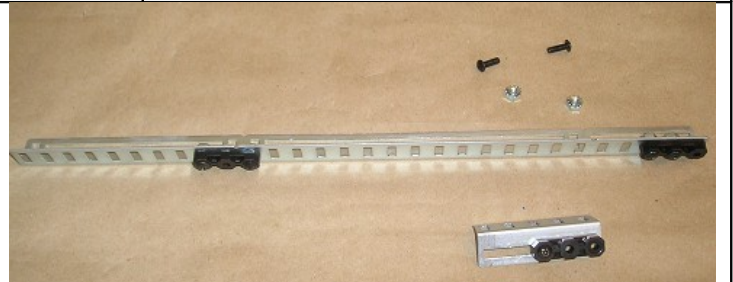
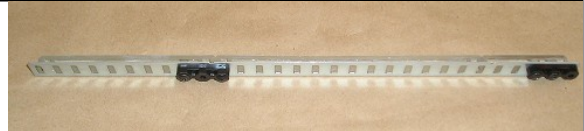
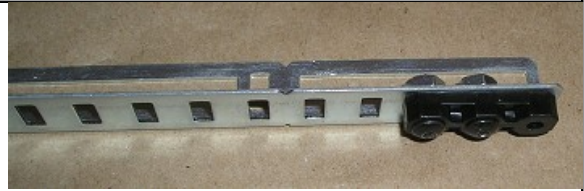

Assemble and attach the tilting mechanism, which uses a servo module to tilt a plate left or right, depending on which color chip is being delivered.

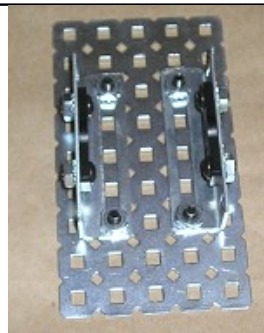
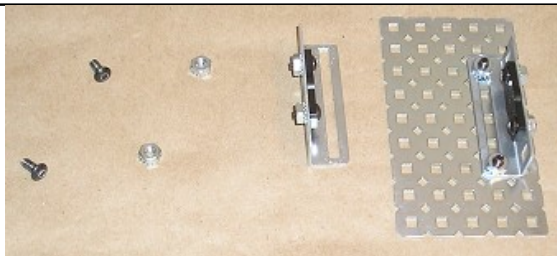
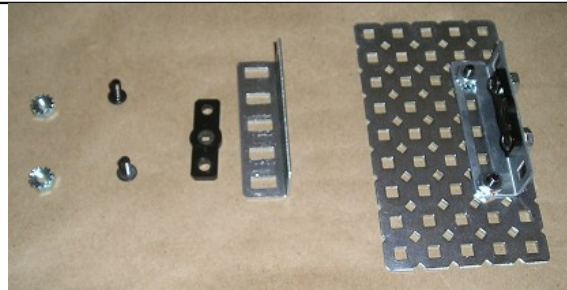
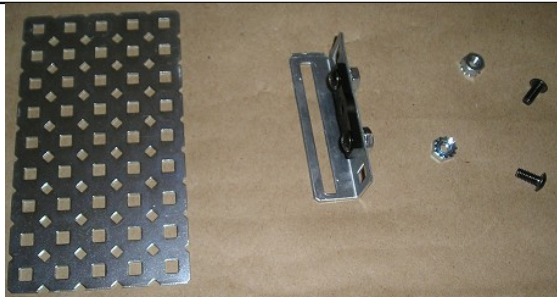
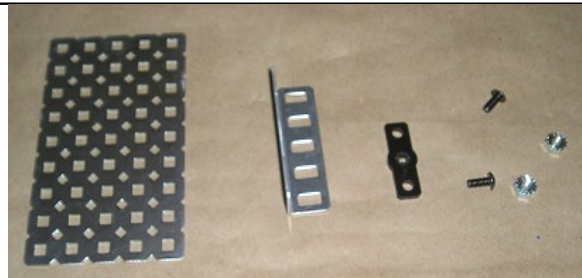
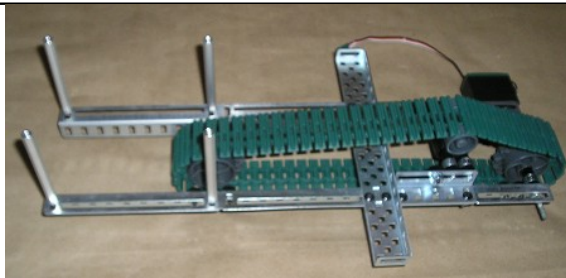
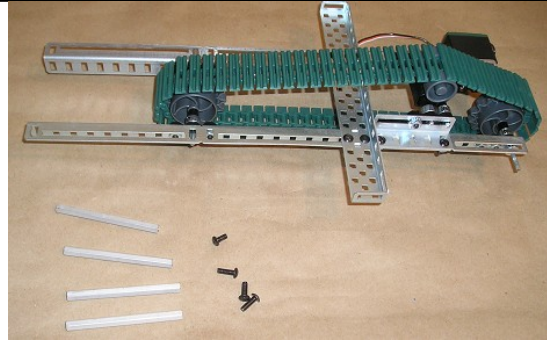
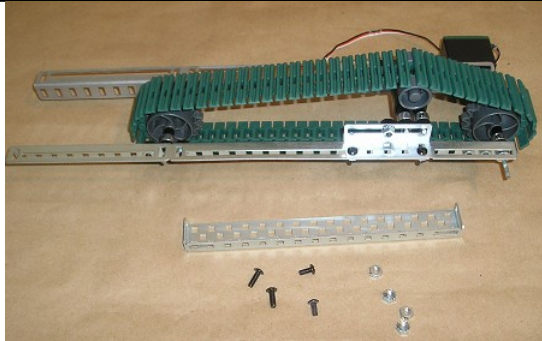

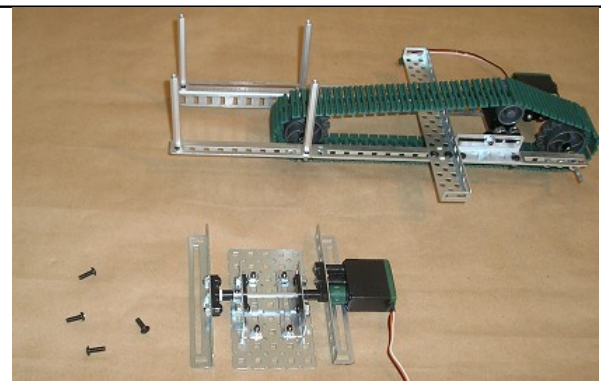
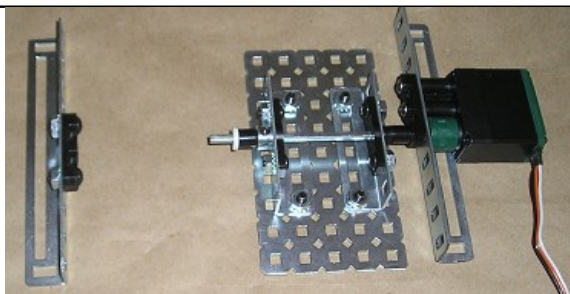
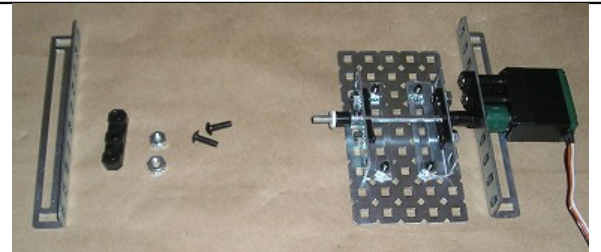
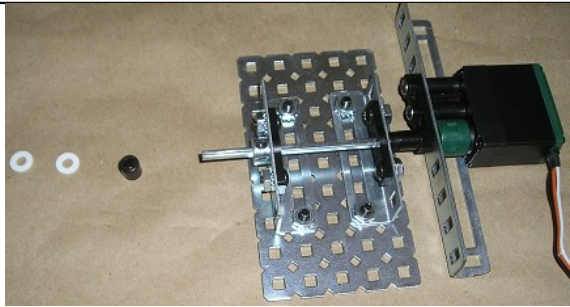
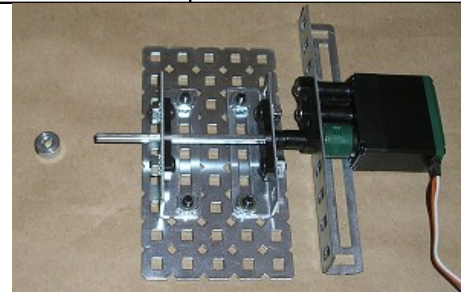
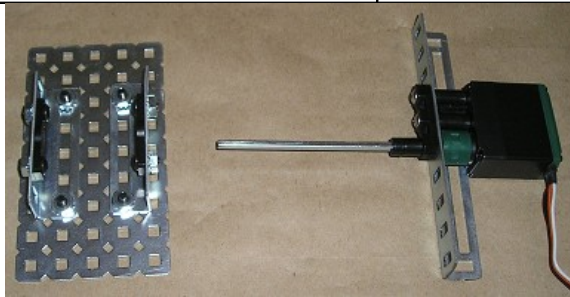
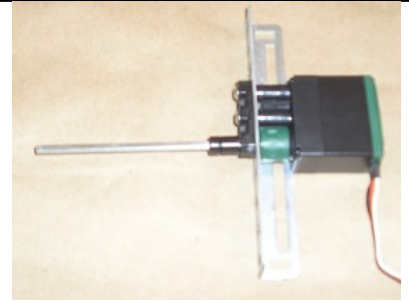
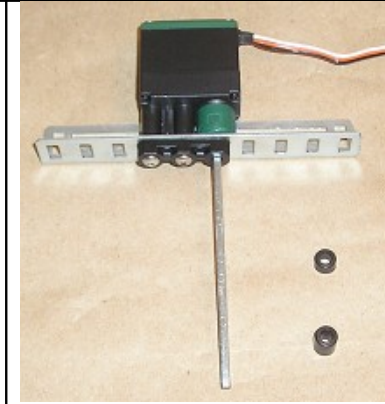

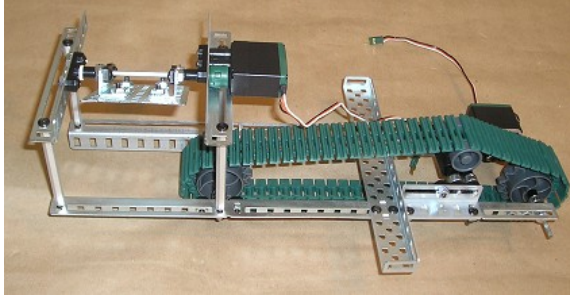

Build a base for the assembly to stand on.

Note: The support structure detailed here uses a large number of threaded beams. If you find yourself running short, you can construct a base from a variety of materials, including unused chasis rails, chasis bumpers, and angle bars. Alternatively, you can skip the base altogether and simply place the robot on two piles of stacked books (an inelegant but fully functional solution to limited resources in the Vex department).

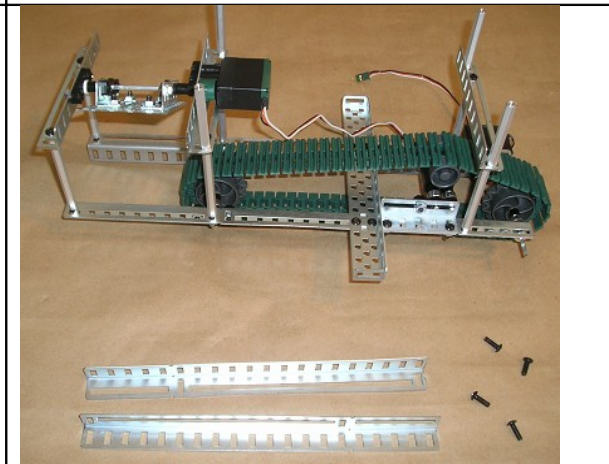
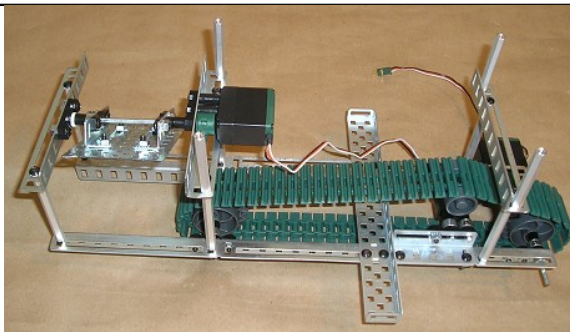
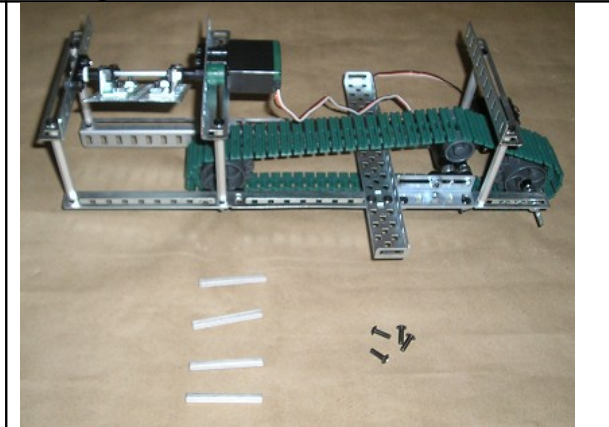
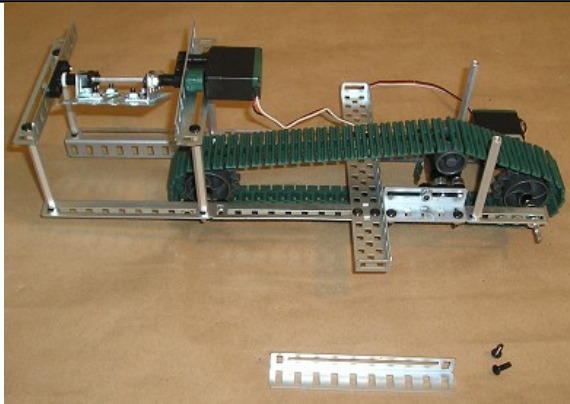

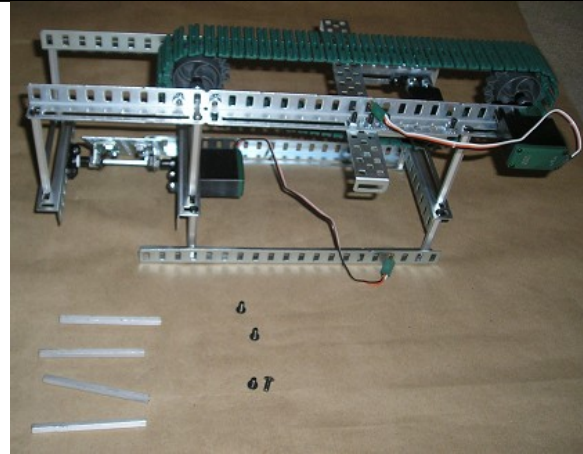
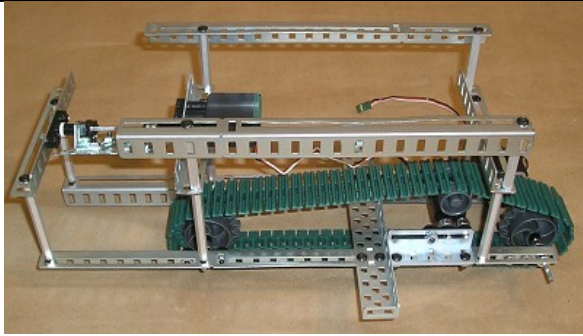

Assemble the structure which will support the line-tracker sensor

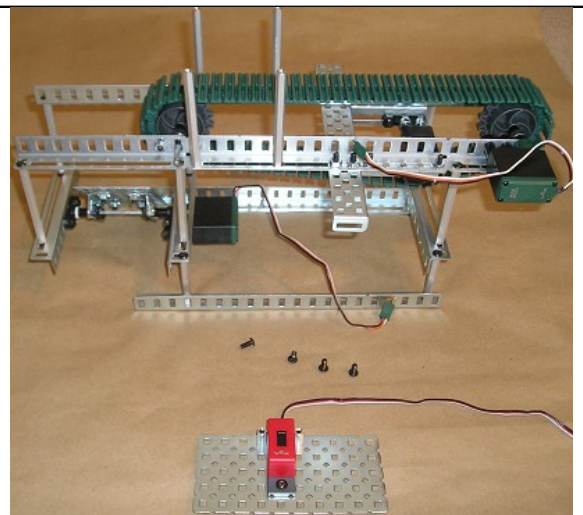
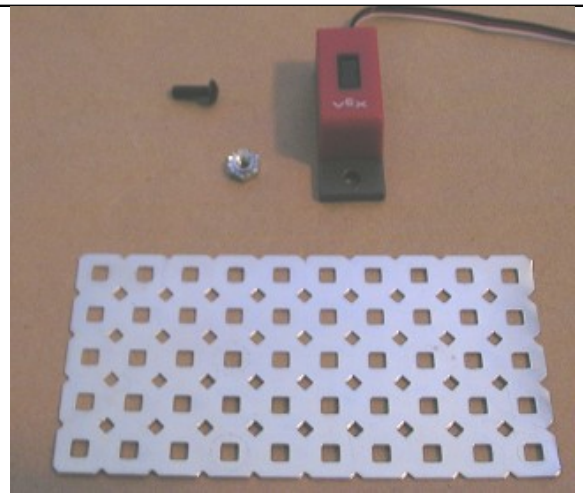
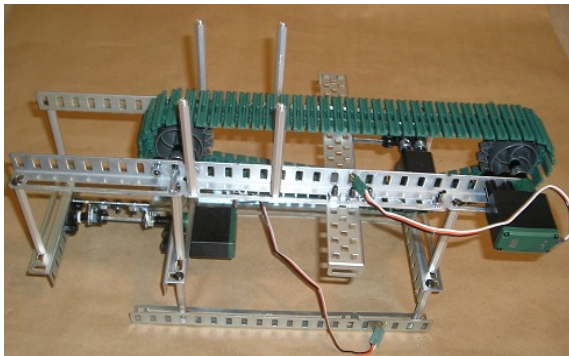

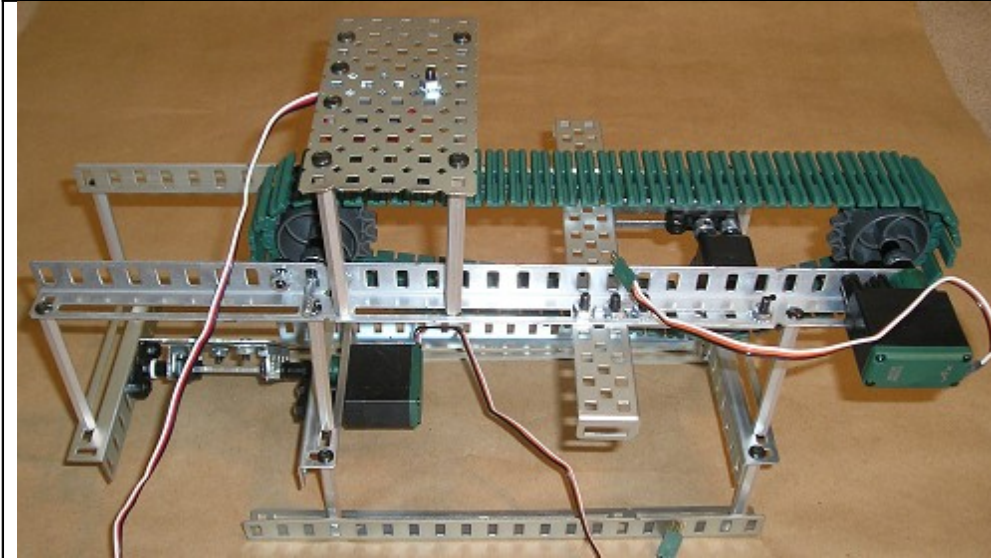

Attach microcontroller and battery. Plug sensor into analog input 1, motor module into motor port 1, servo into motor port 5. Place chips on belt as it moves them down the line.

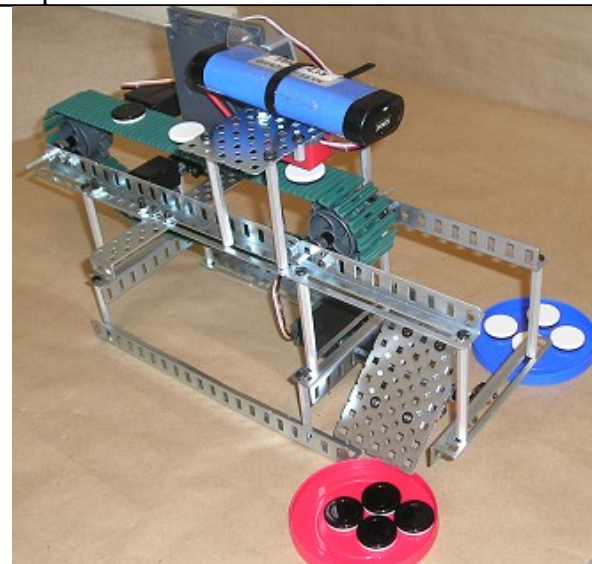
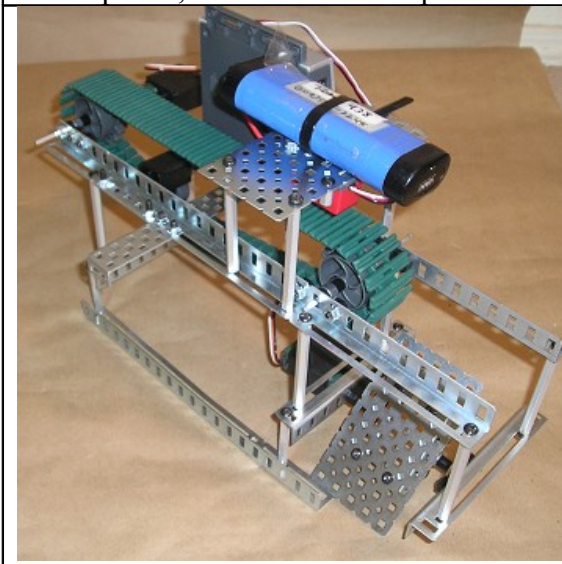

Programming and Operation:

Download the following program, defining the variable "light." Place "light" and "dark" chips on the tank tread belt. The conveyor motor is set to operate at a constant speed, moving the chips to the line follower sensor. When the sensor detects "light" it tilts the delivery plate in one direction. When it detects "dark", which includes both the black chips or no chips (green belt is "dark"), it tilts in the other direction, separating the white chips from the black ones. The chips will need to be positioned (sideways) on the belt so that they pass under the sensor – too far in one direction or the other, and they may not be detected.

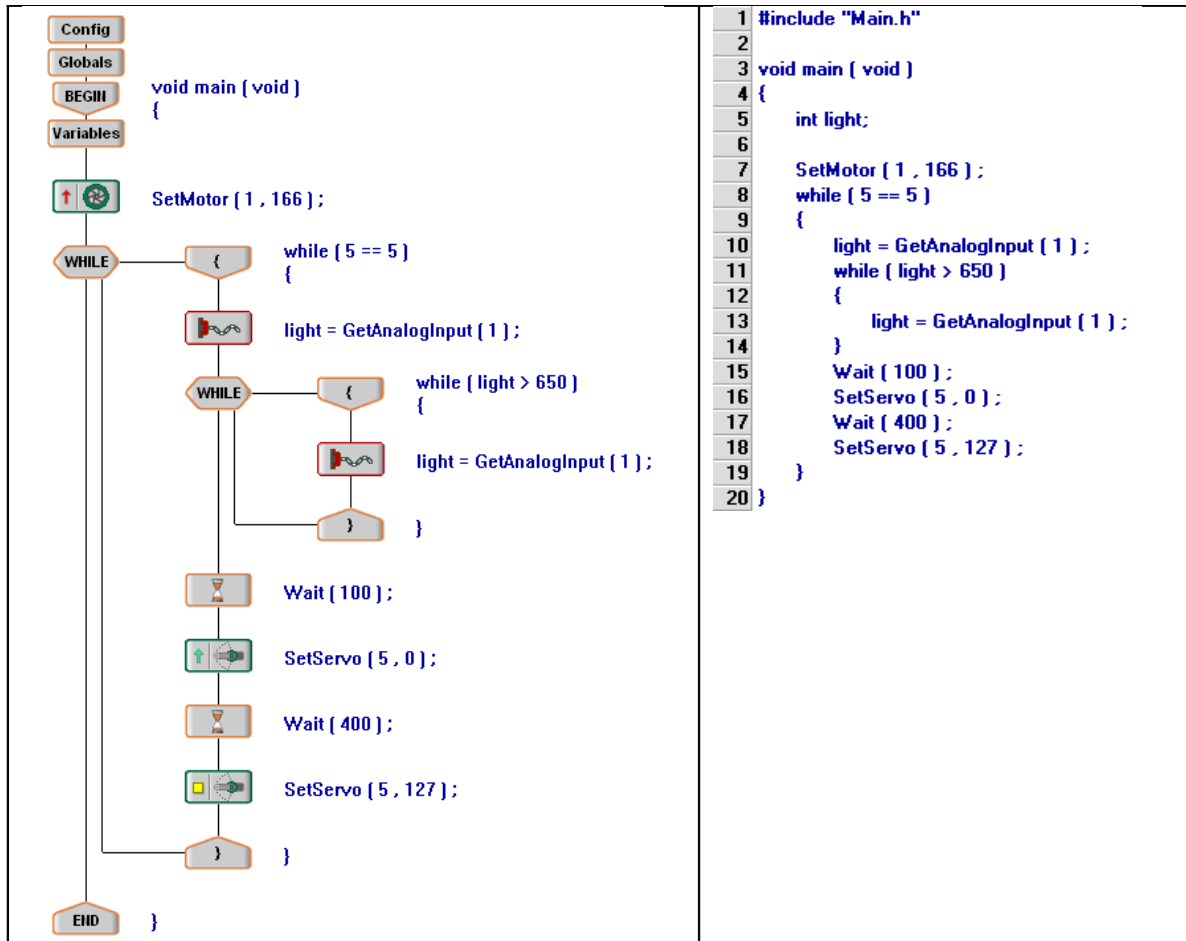

Project Notes and Engineering Principles:

Tank treads have a variety of uses, including wheel substitutes, roller grip mechanisms, and conveyors. Tank tread rollers are essential to keeping the belt taut; alternatively an extra set of wheel hubs can be used.

Mechanically, this is probably the most difficult project in this manual to construct.

Where To From Here?

Once you've worked through the projects in this manual, there are many good projects to try. Although most don't include step-by-step instructions, some of the construction techniques are similar some of these projects, and hopefully you will be able to reverse-engineer. The following are recommended:

- The Vex forum: <http://www.vexforum.com/forum.php>. Under the Community section, check out the Robot Showcase for designs.
- Vex Robotics Official Website: <http://www.vexrobotics.com/>. Click on the Gallery link for photos and videos
- Dedicated user sites. Some good ones (with good pictures and videos) include:
 - <http://www.tonybuildsrobots.tk/>
 - <http://ducttape477.vexrobotics.googlepages.com>
 - <http://www.vexplosion.com/Home.html> (still in development, but a good collection of resources)
- Try searching YouTube and Google for Vex robots or similar entries

Happy trials (and errors) to you!

Appendix A: Recommendations for Vex™ Kit purchase (Summer 2009)

Here are some recommendations for new users looking to purchase a new system. EBay is also a good source of less expensive parts, but it requires that you know what is needed to "fill in the gaps". Vex equipment can be purchased at www.vexrobotics.com.

1. Vex™ Classroom Lab Kit (\$699). Add software for \$50. Although this is expensive, it is the most versatile system and best value for the money. It is recommended even for a home user, if you can afford it. It is the equivalent of the Dual Control Starter Bundle (\$500) + Booster Kit (\$180) + much more. This system will soon become outdated, but can be upgraded by purchasing either the Vexnet Upgrade Bundle (\$150) or the soon to be released Vexnet 2.0 system.
2. Vex™ Radio Control Starter Bundle (\$300). For builders only (no programming capability). Adding the Booster Kit (\$180) greatly expands the building options. In order to add programming capability the options are:
 - a. Add the Microcontroller (\$150), and Programming Kit (\$99). Limit Switches (\$13) and Bumper Switches (\$13) are also desirable. This will soon become outdated.
 - b. Add all the parts in "a" above, plus the Vexnet Upgrade Bundle (\$150). Simply purchasing the Upgrade Bundle alone (\$150) is insufficient.
 - c. When available, purchase the Vexnet 2.0 system. Most likely, a Programming Kit and Limit and Bumper Switches will need to be purchased as well.
3. Vex™ Autonomous Control Starter Bundle (\$400) This is recommended for the individual user who wants to start small and build gradually. It contains programming software. To add radio control capability, the options are:
 - a. Add Transmitter and Receiver kit (\$130). This will soon become outdated
 - b. Add Transmitter and Receiver kit, plus Vexnet Upgrade Bundle (\$150)
 - c. When available, purchase the Vexnet 2.0 system.
4. Vex™ Dual Control Starter Bundle (\$500) This contains both programming and remote control capability and can be used in competition. It can be upgraded with either the Vexnet Upgrade Bundle (\$150) or the soon to be released Vexnet 2.0 system.
5. Vex™ Booster Kit (\$180) - If you already own #2, 3, or 4, this will add a great deal of versatility to your kit
6. Classroom Advanced Sensor Kit (\$100) and Classroom Advanced Drive Kit (\$250) are ways to add capability at a good value. Check the Classroom products for good value, even if you are a single user.
7. There are many other Vex™ add-ons that can be purchased separately. As your skills develop, you will discover which ones will be most suited to your needs. For suggestions see *Appendix B: Additional Parts to Purchase and Cut*.

Appendix B: Additional Parts to Purchase and Cut

Vex pieces are designed to be cut, but novice builders are usually reluctant to cut for fear of "ruining" material. Ordering extra metal and pre-cutting it to frequently used sizes will give a kit more flexibility. Also, if metal-cutting tools are not available on the spot, having pre-cut pieces is necessary. Once builders become more confident, they are more capable of cutting pieces while minimizing the amount of waste.

A. Recommended Add-ons to a Protobot kit alone

Part Name	Part #	# To order	Price	Total Cost
Drive Shaft Square Bar Pack	SQR-BAR-120-2PK	3	\$4.49	\$13.47
Collar Pack	COLLAR-16PK	1	\$10.49	\$10.49
Angle 1 X 1	P/N: ANGLE-001-4PK	1	\$14.99	\$14.99
Angle 1 X 1 , Inverse	P/N: ANGLE-001R-4PK	1	\$14.99	\$14.99
1/2 in. 8-32 Screw Pack	SCREW-832-12-28PK	1	\$1.49	\$1.49
3/4 in. 8-32 Screw Pack	SCREW-832-34-14PK	1	\$0.99	\$0.99
Delrin Bearing 10-pack	BEARING-FLAT-10PK	1	\$4.99	\$4.99
Open End/Allen Wrench Pack	WRENCH-ALLEN-TOOL- PK	1	\$2.99	\$2.99
25 X 5 Hole Plate	PLATE-25-5-4PK	1	\$14.99	\$14.99
Bar 1 X 25 Holes pack	BAR-25-4PK	1	\$5.49	\$5.49
Total				\$84.88

B. Recommended Add-ons to a Protobot Kit + Booster Kit (the Classroom Lab kit contains these 2 kits)

Part Name	Part #	# To order	Price	Total Cost
Drive Shaft Square Bar Pack	SQR-BAR-120-2PK	1	\$4.49	\$4.49
Angle 1 X 1	P/N: ANGLE-001-4PK	1	\$14.99	\$14.99
Angle 1 X 1 , Inverse	P/N: ANGLE-001R-4PK	1	\$14.99	\$14.99
Open End/Allen Wrench Pack	WRENCH-ALLEN-TOOL- PK	1	\$2.99	\$2.99
25 X 5 Hole Plate	PLATE-25-5-4PK	1	\$14.99	\$14.99
Total				\$52.45

How to cut

- Angles 1 X 1 (15" long) – 4 total (or 6 total with Booster Kit)
 - *Cut one piece into 10" + 5" (on the notch)
 - *Cut one piece into 12.5" + 2.5" (on the notch)
 - Leave 2 pieces uncut
 - (If adding to a Booster Kit , cut 2 pieces for * entries, leaving 2 pieces uncut)

2. Angles 1 X 1, inverse (15" long) – 4 total (or 6 total with Booster Kit)
 - *Cut one piece into 10" + 5" (on the notch)
 - *Cut one piece into 12.5" + 2.5" (on the notch)
 - Leave 2 pieces uncut
 - (If adding to a Booster Kit , cut 2 pieces for * entries, leaving 2 pieces uncut)

3. Drive Shaft Square Bars (12" long) – 6 total (no notches)
 - Cut one piece into 6" + 6"
 - Cut 2 pieces into 8" + 4"
 - Cut one piece into 4" + 4" + 4"
 - Leave 2 pieces uncut

4. Plates 25 X 5 (25 squares long, 5 squares wide) – 6 total
 - Cut 2 pieces with width 5 squares, lengths: 4 + 6 + 8 + 7 squares = 25 squares
 - Cut 2 pieces with width 5 squares, lengths: 3 + 10 + 12 squares = 25 squares
 - Leave 2 pieces uncut

5. Bars 1 X 25 can easily be cut to size on the spot with a pair of tin snips or strong wire cutters (keep a file handy for sharp edges). No standard sizes are recommended.